

# HOUSINGS AND ACCESSORY PRODUCTS

## Manifold Accessories

### SAE PORT PLUGS

Available in Hex Head or Hex Socket Versions.

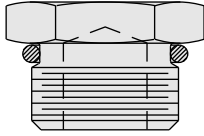

#### Hex Head O-Ring Boss Plug

Size	Part No.
SAE 2	6103102
SAE 4	6103104
SAE 6	6103106
SAE 8	6103108
SAE 10	6103110
SAE 12	6103112
SAE 16	6103116
SAE 20	6103120

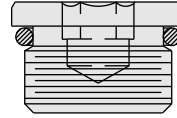

#### Hex Socket O-Ring Boss Plug

Size	Part No.
SAE 2	6103002
SAE 4	6103004
SAE 6	6103006
SAE 8	6103008
SAE 10	6103010
SAE 12	6103012
SAE 16	6103016
SAE 20	6103020

### ORIFICE PLUGS

Made from a 3/16" hex socket plug, orifice plugs can be pre-drilled or ordered as blanks. Orifice diameters can range from .020" to .180".

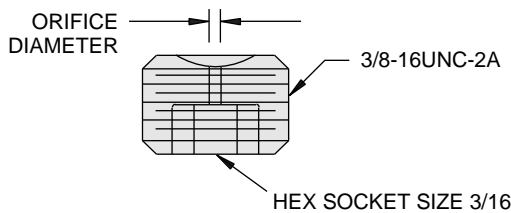

#### To Order:

6112

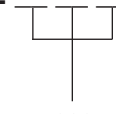

000  
XXX

#### Orifice Size

Blank (No Orifice) or ...  
Specify Orifice Diameter  
from .020 to .187

Note: Minimum drill diameter is 0.020 in.  
For smaller orifice sizes consult factory.

### ORIFICE PLATES

Orifice Plates produce a higher restriction in one direction and a lower restriction in the other direction.

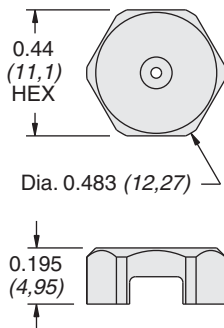

Inch  
(mm)

#### STANDARD POSITION

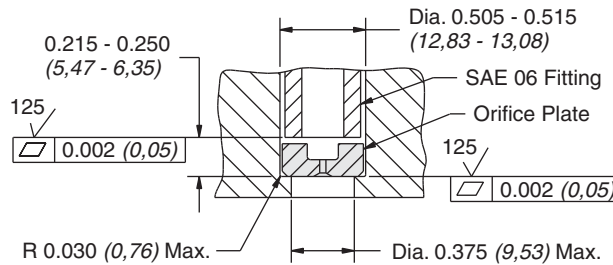

Flow is regulated from a hydraulic cylinder or motor, to the control valve

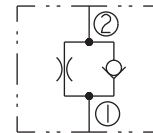

#### INVERTED POSITION

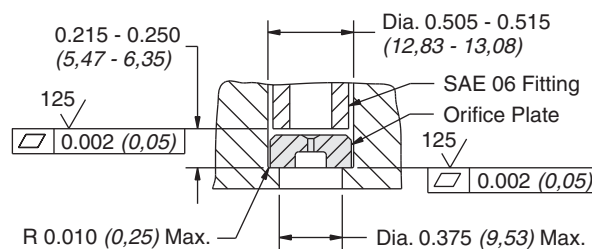

Flow is regulated from the control valve, to a hydraulic cylinder or motor

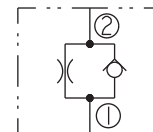

#### Orifice Plates

Orifice Dia.	Part No.
0.037 ±0.002	4500210
0.046 ±0.002	4500220
0.059 ±0.002	4500230
0.030 ±0.002	4531610
0.120 ±0.002	4531840
0.156 ±0.002	4531850
0.032 ±0.002	4536440

## Manifold Accessories (cont'd)

### SCREEN CARTRIDGES

These 100-mesh screen cartridges are not recommended substitutes for hydraulic filters. However, they are good low-cost "rock catchers" for shielding control orifices, pilot lines, etc. Use SCxx cartridges for flow from port 2 to port 1 only.

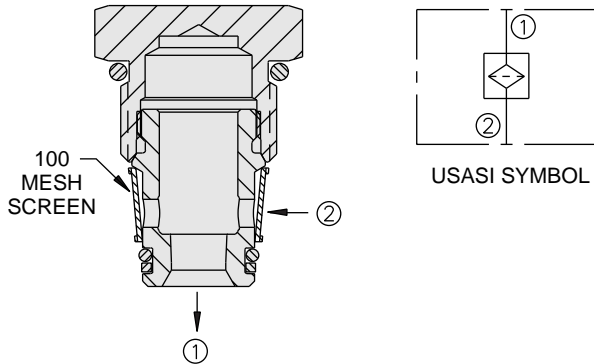

Size	Model	Part No.
08	SC08-20-0-N-100	5290210
10	SC10-20-0-N-100	5291210

### ADAPTER LOCK KITS

Lock kits can be used to help prevent valves from backing out of the cavity. Kits include adapter plate, lock washer and machine screw.

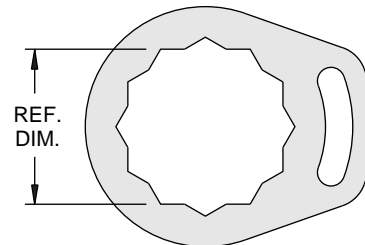

Valve Type	Ref. Dim.	Kit Part No.
MR10	1 in.	5399000
PV70 & ZL70	1 <sup>1</sup> / <sub>8</sub> in.	4205140
PD12	1 <sup>1</sup> / <sub>4</sub> in.	5960110
PD16	1 <sup>1</sup> / <sub>2</sub> in.	5960108
EP20 & PD42	1 <sup>7</sup> / <sub>8</sub> in.	5960109

### PILOT PISTONS

Pilot pistons can be successfully applied in aluminum housings if the designer and the fabricator prepare the bore correctly.

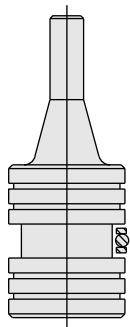

#### Single Piston

Size	Without Seals Part No.	With Seals Part No.	Cavity
08	7013280	7013280S	VC08-PCV
10	7013200	7013200S	VC10-PCV
12	7013360	7013360S	VC12-PCV
16	7013170	7013170S	VC16-PCV

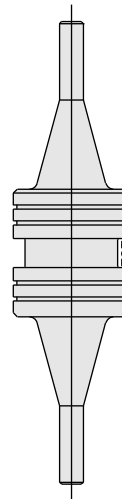

#### Double Piston

Size	Without Seals Part No.	With Seals Part No.	Cavity
08	7013380	7013380S	VC08-DCV
10	7013300	7013300S	VC10-DCV
12	7013340	7013340S	VC12-DCV

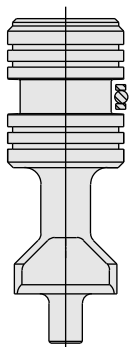

#### Heavy Duty Piston

Includes oil passage in nose for use with center-hole poppets.

Size	Without Seals Part No.	With Seals Part No.	Cavity
10	7030310	7030310S	VC10-PCV

#### See Pilot Piston Cavity details in Catalog Section 9:

08-size cavities: section 9.108.1  
 10-size cavities: section 9.110.1  
 12-size cavities: section 9.112.1  
 16-size cavities: section 9.116.1