

# PE12-S67K Proportional, Pilot Operated

U.S. Patent  
6,554,014

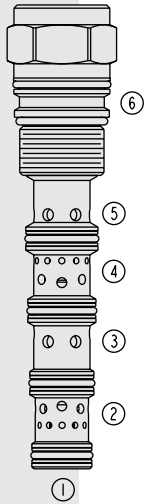

## DESCRIPTION

A screw-in, cartridge-style, proportional, spring-centered, pilot-operated spool-type hydraulic directional valve.

## OPERATION

When the PE12-S67K is in the neutral position, port ③ is blocked while ②, ④ and ⑤ are connected to each other. When the remote pilot signal at ① exceeds the force of the bias spring, the spool shifts proportionally to the applied pilot pressure to allow flow from ③ to ④ through a load such as a hydraulic cylinder or motor, and from ② to ⑤ and to tank. On remote pilot signal at ⑥, the valve's spool shifts proportionally to the applied pressure in the opposite direction, reversing the flow direction.

**The valve's spool is non-symmetrical, providing meter-in control.**

## FEATURES

- Hardened parts for long life.
- Excellent metering characteristics.
- Good linearity.

## RATINGS

### Maximum Operating Pressure:

- Ports ③ and ⑥: 345 bar (5000 psi), polyurethane seals are recommended.
- Ports ② and ④: 240 bar (3500 psi)
- Ports ① and ⑥: 27.6 bar (400 psi)

**Flow:** See Performance Chart

**Internal Leakage:** 36 ml/minute (2.2 cu. in./minute) at 207 bar (3000 psi)

**Temperature:** -40 to 120°C with standard Buna N seals

**Filtration:** See page 9.010.1

**Fluids:** Mineral-based or synthetics with lubricating properties at viscosities of 7.4 to 420 cSt (50 to 2000 sus); See Temperature and Oil Viscosity, page 9.060.1

**Installation:** No restrictions; See page 9.020.1

**Cavity:** VC12-S6; See page 9.112.1

**Cavity Tool:** CT12-S6; See page 8.600.1

**Seal Kit:** SK12-6X-BMMMM; See page 8.650.1

## SYMBOLS

### USASI:

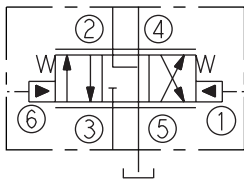

### ISO:

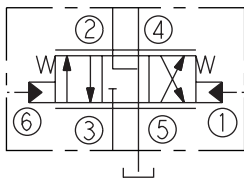

## PERFORMANCE (Cartridge Only)

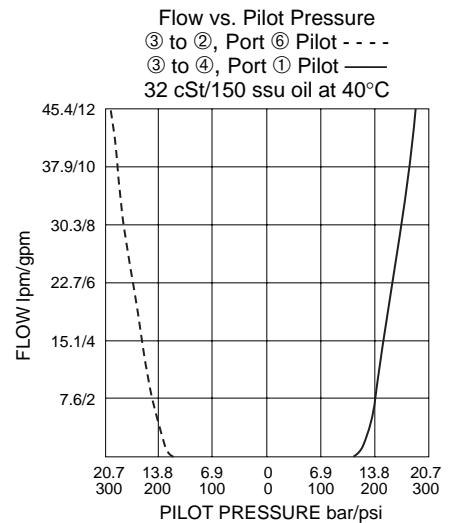
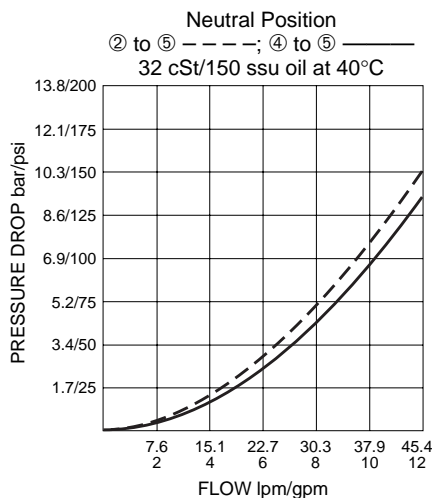
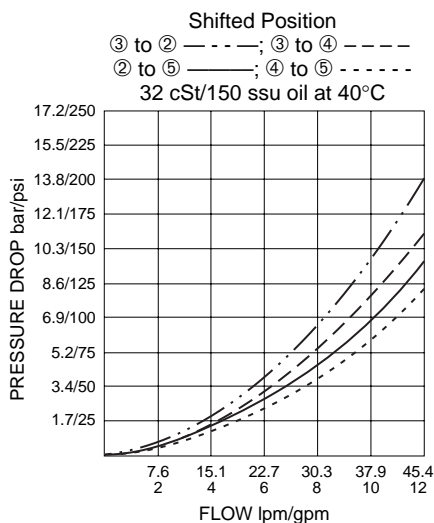

**DIMENSIONS**

U.S. Patent 6,554,014

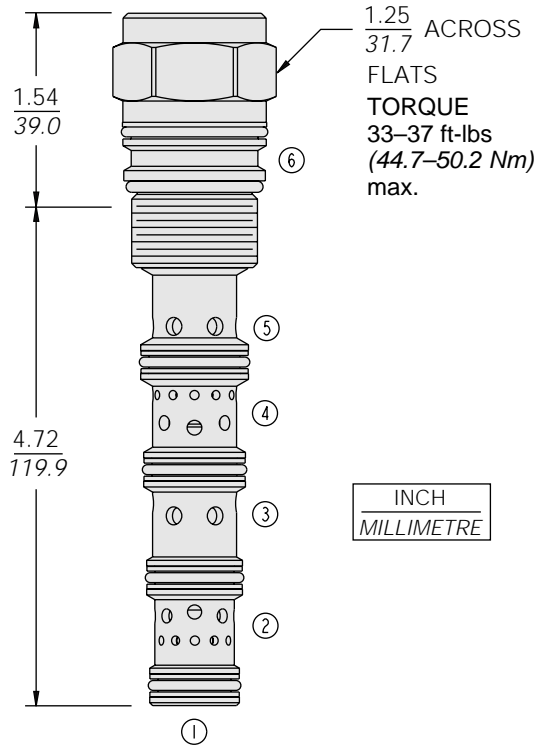

**MATERIALS**

**Cartridge:** Weight: 0.45 kg. (0.98 lbs.)  
Steel with hardened work surfaces.  
Zinc-plated exposed surfaces.  
Buna N O-rings and polyester elastomer back-ups standard.

**Ported Body:** Test housing available.  
See page 8.012.1

**TO ORDER**

**PE12-S67K - -**

**Porting**  
Cartridge Only **0**

**Seals**  
**N** Buna N (Std.)  
**P** Polyurethane (for pressures over 240 bar/3500 psi)  
**V** Fluorocarbon