

PE16-S67K Proportional, Pilot Operated

U.S. Patent
6,554,014

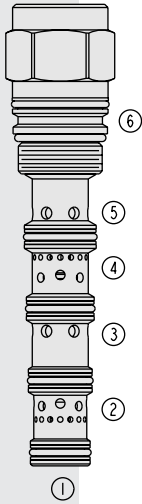

DESCRIPTION

A screw-in, cartridge-style, proportional, spring-centered, pilot operated spool valve.

OPERATION

When the PE16-S67K is in neutral position, inlet port ③ is blocked while ports ②, ④ and ⑤ are connected to each other. With remote pilot signal at port ①, the valve's spool shifts proportionally to the applied pilot pressure to allow flow from ③ to ④ through a load such as a hydraulic cylinder or motor, and then from ② to ⑤ and to tank. Port ② is open during transition. On remote pilot signal at ⑥, the spool shifts proportionally to the applied pressure in the opposite direction, reversing the flow direction. Port ④ is open during transition. **The spool is non-symmetrical, providing only meter-in control.**

FEATURES

- Hardened spool and cage for long life.
- Cost-effective cavity.
- Excellent metering characteristics.
- Good linearity.

RATINGS

Maximum Operating Pressure: Port ③: 345 bar (5000 psi)
Ports ② and ④: 240 bar (3500 psi)
Ports ① and ⑥: 27.6 bar (400 psi)

Flow: See Performance Chart

Internal Leakage: 197 ml/minute (12 cu. in./minute) at 207 bar (3000 psi) maximum

Temperature: -40 to 120°C with Buna N seals

Filtration: See page 9.010.1

Fluids: Mineral-based or synthetics with lubricating properties at viscosities of 7.4 to 420 cSt (50 to 2000 sus); See Temperature and Oil Viscosity, page 9.060.1

Installation: No restrictions; See page 9.020.1

Cavity: VC16-S6; See page 9.116.1

Cavity Tool: CT16-S6; See page 8.600.1

Seal Kit: SK16-S6X-BMMMM; See page 8.650.1

SYMBOLS

USASI:

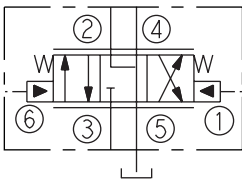

ISO:

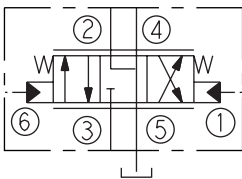

PERFORMANCE (Cartridge Only)

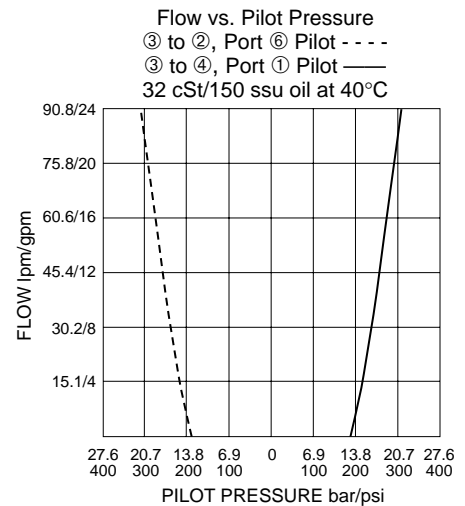
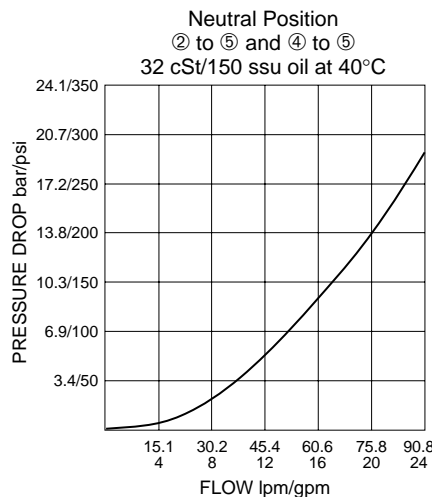
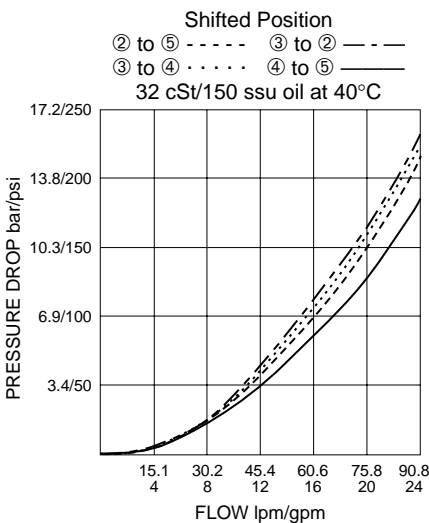

DIMENSIONS

U.S. Patent 6,554,014

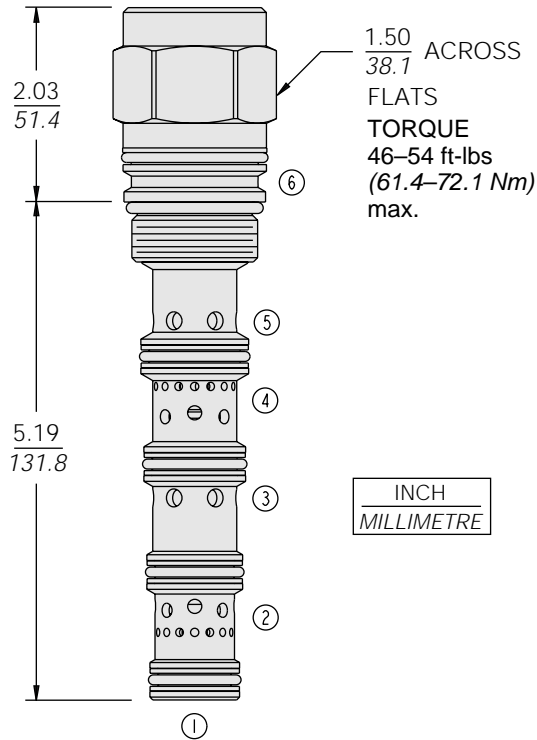

MATERIALS

Cartridge: Weight: 0.76 kg. (1.68 lbs.)
Steel with hardened work surfaces.
Zinc-plated exposed surfaces.
Buna N O-rings and polyester
elastomer back-ups standard.

Test Body: Consult Factory

TO ORDER

PE16-S67K - -
Porting
Cartridge Only 0

Seals

- N** Buna N (Std.)
- P** Polyurethane (for pressures over 240 bar/3500 psi)
- V** Fluorocarbon