

ELECTRO-PROPORTIONAL VALVES—DIRECTIONAL CONTROL

SP08-22 Poppet, 2-Way, Normally Closed

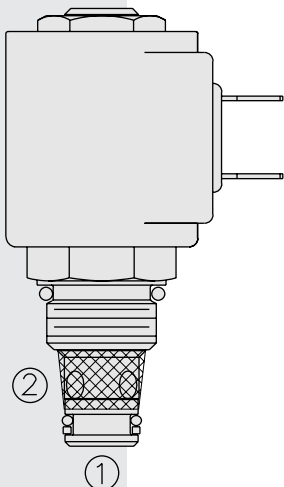

DESCRIPTION

A proportional solenoid-operated, 2-way, bi-directional, poppet-type, normally closed, screw-in hydraulic cartridge valve for low-leakage blocking and load-holding.

OPERATION

When de-energized, the **SP08-22** acts as a check valve, allowing flow from ① to ②, while blocking flow from ② to ①. When energized, the poppet lifts to open the ② to ① flow path. Flow is proportional to current applied to the coil. The reverse-flow check allows unrestricted flow from ① to ② when the valve is energized, but this flow is not proportional to the current.

Note: External circuitry is required to ramp current.

Note: If low voltage is expected on the machine, 12 or 24 volt systems will require the use of 10 volt or 20 volt coils respectively. See “SP Valves and Coil Operating Parameters,” page 2.002.1.

FEATURES

- Industry-common cavity.
- Hardened steel work surfaces.
- Continuous-duty rated coils.
- Optional waterproof E-Coils rated up to IP69K

RATINGS

Operating Pressure: 207 bar (3000 psi)

Flow: 30.3 lpm (8 gpm) nominal

Max. Internal Leakage: 5 drops per minute at 207 bar (3000 psi)

Temperature: -40 to 100°C with standard Buna seals

Filtration: Recommend ISO 4406 16/13; See page 9.010.1

Fluids: Mineral-based or synthetics with lubricating properties at viscosities of 7.4 to 420 cSt (50 to 2000 sus); See Temperature and Oil Viscosity, page 9.060.1

Installation: No Restrictions. See page 9.020.1

Cavity: VC08-2; See page 9.108.1; **Cavity Tool:** CT08-2XX; See page 8.600.1

Seal Kit: SK08-2X-M; See page 8.650.1

Coil Nut: Part No. 7004400; For E-coils manuf. prior to 1-1-04, see page 3.400.1

SYMBOLS

USAS/ISO:

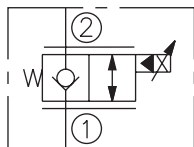

PERFORMANCE

TYPICAL PRESSURE DROP ② to ① with 12 VDC Coil

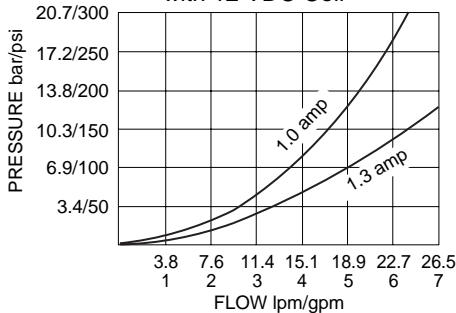

TYPICAL PRESSURE RESPONSE 12 VDC Coil

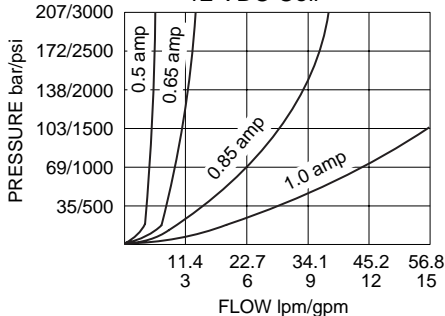

FLOW vs. CURRENT at Various Differential Pressures for Standard Coils (consult factory for E-Coils) 32 cSt/150 sus oil at 40°C

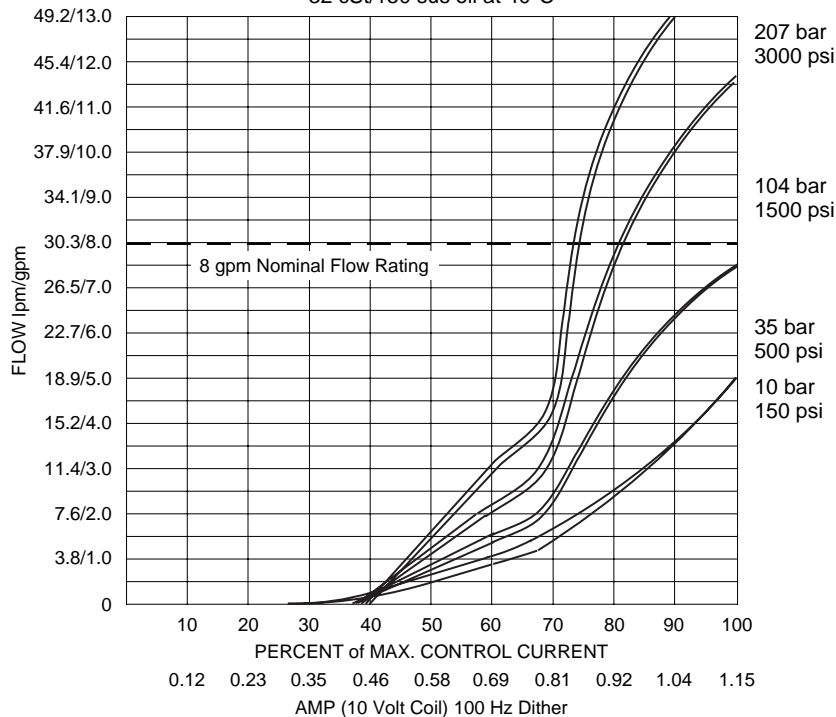

PERFORMANCE (cont'd.)

PERCENT I-MAX. vs. TEMPERATURE
for 10 or 20 VDC Coil (for 10V Coil I-Max. = 1.15A)
Curves show percent of nominal system voltage minus 1.5V drop across controller

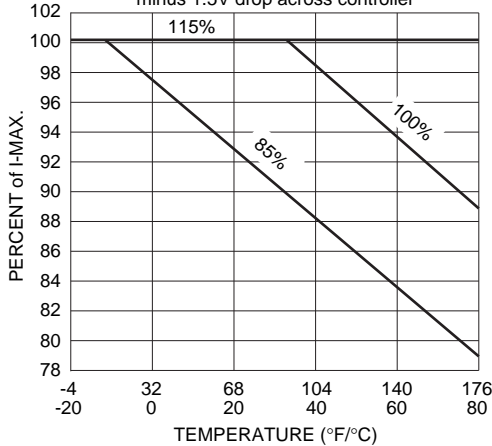

Recommended Electronic Controllers:
See page 2.001.1 or our Electronics catalog.

DIMENSIONS

COIL MUST BE INSTALLED WITH LETTERING UP

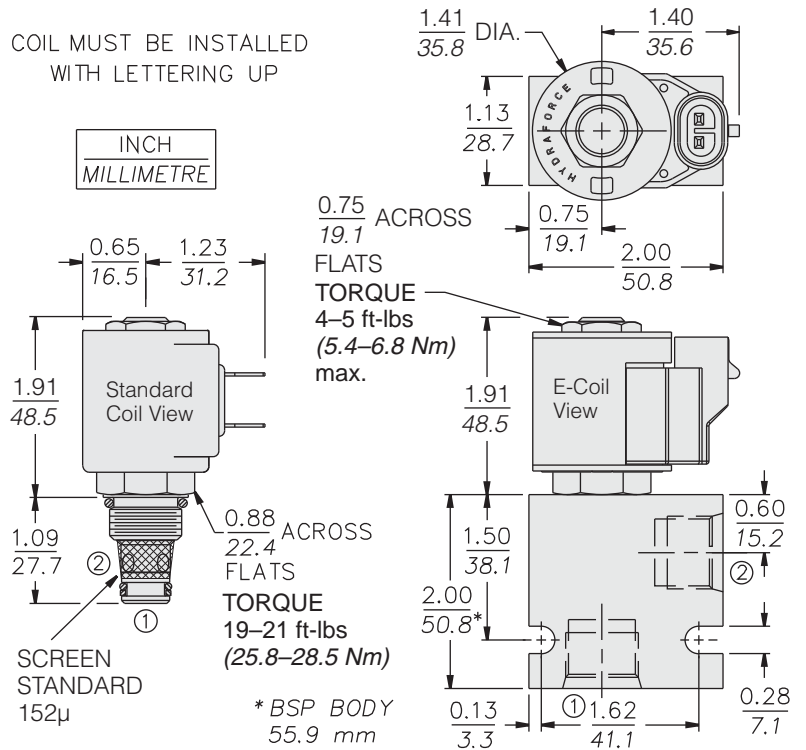

MATERIALS

Cartridge: Weight: 0.10 kg. (0.23 lbs.) Steel with hardened work surfaces. Zinc-plated exposed surfaces. Buna N O-rings and back-ups standard.

Standard Ported Body: Weight: 0.16 kg. (0.35 lbs.) Anodized high-strength 6061 T6 aluminum alloy, rated to 240 bar (3500 psi). Ductile iron bodies available; dimensions may differ. See page 8.008.1

Standard Coil: Weight: 0.11 kg. (0.25 lbs.) Unitized thermoplastic encapsulated, Class H high temperature magnetwire. See page 3.200.1

E-Coil: Weight: 0.14 kg. (0.3 lbs.) Perfect wound, fully encapsulated with rugged external metal shell. Rated up to IP69K with integral connectors. **Note: See page 3.400.1 for all E-Coil retrofit applications.**

TO ORDER

