

ELECTRO-PROPORTIONAL VALVES—FLOW CONTROLS

PFR70-33x-E Proportional Flow Regulator, N.C.,

SYMBOLS

USASI:

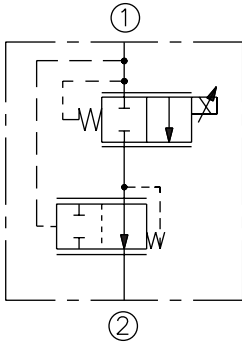

ISO:

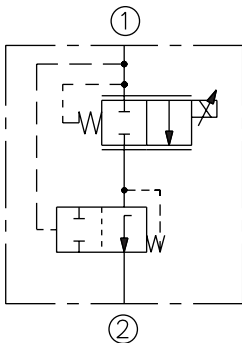

Attention Manifold Designers:

To obtain these high flow capabilities using proportional flow controls and compensators, optimized cavity drillings are required. Please consult factory.

DESCRIPTION

A pressure-compensated electrically-variable two-port flow regulator that is normally closed when de-energized. This combination valve uses a PV70-33x proportional cartridge and an EC10-30 compensator.

OPERATION

This proportional valve/compensator package will regulate flow out of port ②, regardless of system working pressure. With an increasing current applied to the solenoid, the PFR70-33x-E will increase output flow.

FEATURES

- Excellent linearity and hysteresis.
- Optional control orifice sizes.
- Hardened spool and cage for long life.
- Optional coil voltages and terminations.
- Efficient wet armature construction.
- Efficient wet armature construction.
- Cartridges voltage interchangeable.
- Unitized, molded coil design.
- Coil waterproofing standard.
- Screw-in manual override option.

RATINGS

Operating Pressure: 207 bar (3000 psi)

Internal Leakage: 410 cc/min. (25 cu. in./min.) fully closed at 207 bar (3000 psi) out port ②.

Electrical: 2 standard voltage ratings

Coil Voltage	Threshold Current (mA)		Max. Control Current (mA)	
	A & B Range	C Range	A & B Range	C Range
12 VDC	300 ± 70	360 ± 70	1500 ± 200	1400 ± 200
24 VDC	150 ± 35	180 ± 35	750 ± 100	700 ± 100

Operation of Manual Override:

To Engage: Turn clockwise approximately 1 turn to reach start point. Continue another approximately 5 turns to full shift.

To Disengage: Turn counterclockwise approximately 6 turns until positive stop is found.

Filtration: See page 9.010.1

Fluids: Mineral-based or synthetics with lubricating properties at viscosities of 7.4 to 420 cSt (50 to 2000 sus); See Temperature and Oil Viscosity, page 9.060.1

Installation: No restrictions; See page 9.020.1

PERFORMANCE CURVES Regulated Flow Delivered Out Port ②:

24 Volt coil used; 130 Hz dither; PWM controller. For 12 volt coils, double the current (amp) values shown.

Flow vs. Current (207 bar/3000 psi Load)
PV70-33A with EC10-30
11 bar/160 psi spring —
5.5 bar/80 psi spring - - -
100 Hz Dither

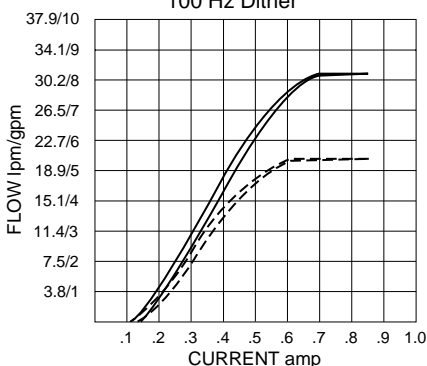

Flow vs. Current (207 bar/3000 psi Load)
PV70-33B with EC10-30
11 bar/160 psi spring —
5.5 bar/80 psi spring - - -
100 Hz Dither

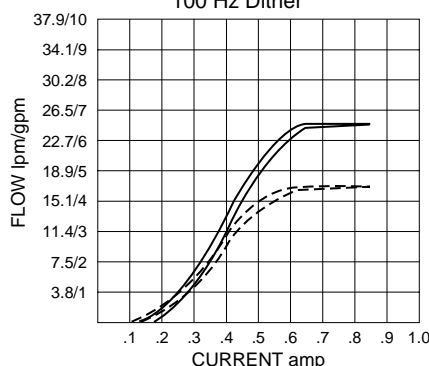

Flow vs. Current (207 bar/3000 psi Load)
PV70-33C with EC10-30
11 bar/160 psi spring —
5.5 bar/80 psi spring - - -
100 Hz Dither

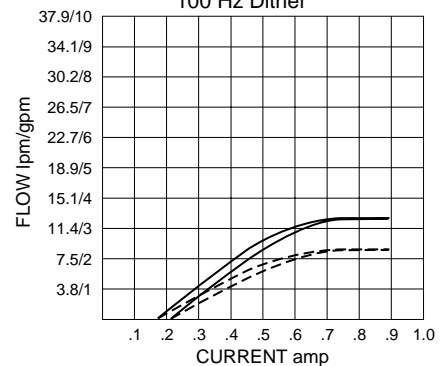

2-Port, Pressure Compensated

PFR70-33x-E

DIMENSIONS

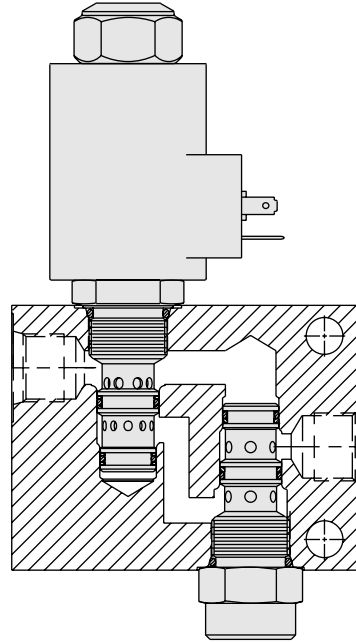
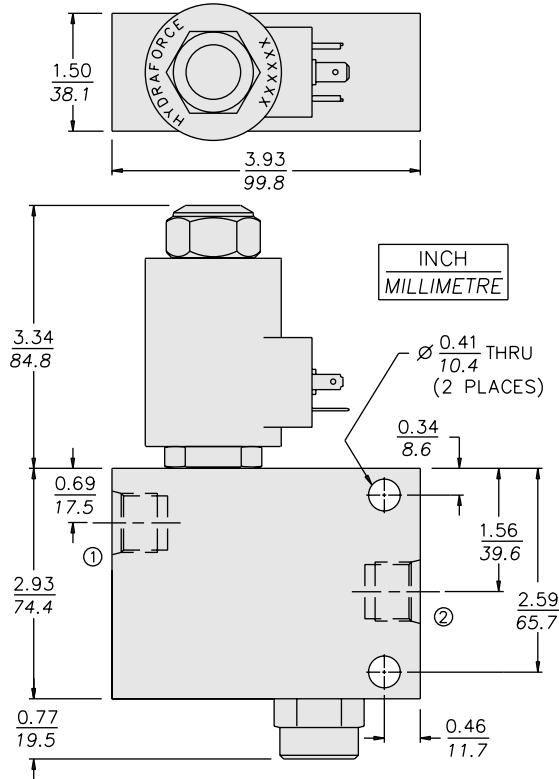

NOTE: The normally open PV70-35 may not be substituted in this manifold due to port logic factors.

MATERIALS

Cartridge: Steel with hardened work surfaces. Zinc-plated exposed surfaces. Buna N O-rings and back-ups standard.

Standard Ported Body: Anodized high-strength 6061 T6 aluminum alloy, rated to 207 bar (3000 psi). Ductile iron bodies available; dimensions may differ. Consult factory.

Coil: D-Coil: See page 3.200.1
E-Coil: See page 3.400.1

Package Weight: 2.27 kg. (5 lbs.)

Seal Kit: SK10-3x-MM (PV)
SK10-3x-TB (EC)

TO ORDER

