

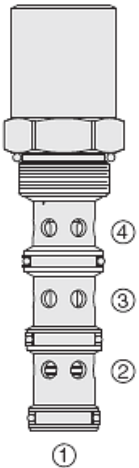

Overview



Description

EC16-43 is a screw-in, cartridge style, priority on demand pressure compensator valve with dynamic load sense. It is intended to provide priority flow in required amount, while allowing excessive flow to be used for auxiliary functions.

Operation

With inlet flow at port 3, the EC16-43 will deliver required priority flow at port 4 regardless of load pressure. Excessive flow exits at port 2 and port 1 is the load sense port. All ports may be fully pressurized.

Features

- Priority-on-demand
- Dynamic load sense
- Hardened parts for long life.
- Quiet, modulated response.
- Industry-common cavity.

Symbol

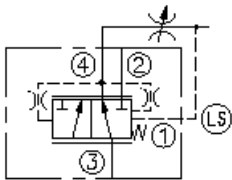

Ratings

Pressure Ratings

Pressure rating	241 bar (3500 psi)
Proof pressure	690 bar (10000 psi)
Burst pressure	1275 bar (18500 psi)

Flow Ratings

Inlet flow rating	115 lpm (30.0 gpm)	- Note: Maximum, with compensating spring 5.5 bar (80 psi)
	150 lpm (40.0 gpm) (150 psi)	- Note: Maximum, with compensating spring 10.3 bar
	189 lpm (50.0 gpm) (220 psi)	- Note: Maximum, with compensating spring 15.2 bar
Priority flow rating	80% of input flow when priority pressure exceeds bypass pressure; 50% of input inflow when bypass pressure exceeds priority pressure	

Temperature Ratings

Operating fluid temperature	-40 to 100 °C (-40 to 212 °F)	- Note: With buna N seals
	-26 to 204 °C (-15 to 400 °F)	- Note: With fluorocarbon seals
	-54 to 107 °C (-65 to 225 °F)	- Note: With polyurethane seals
Storage temperature	-40 to 70 °C (-40 to 160 °F)	
Ambient temperature	-40 to 70 °C (-40 to 160 °F)	

Operating Parameters

Fluids	Mineral based or synthetic hydraulic fluid with lubricating properties
Fluid viscosity range	7.4 to 420 cSt
Maximum operating contamination level	18/16/13 per ISO 4406



Properties

Unit weight	0.65 kg (1.44 lb)
Internal wetted surface area	441 cm ² (68.4 in ²)

Performance

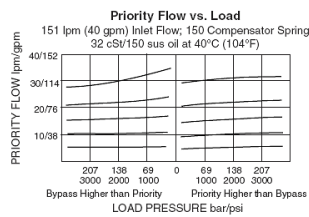
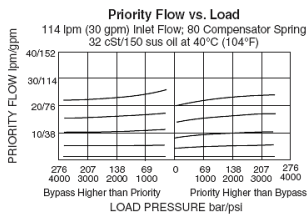
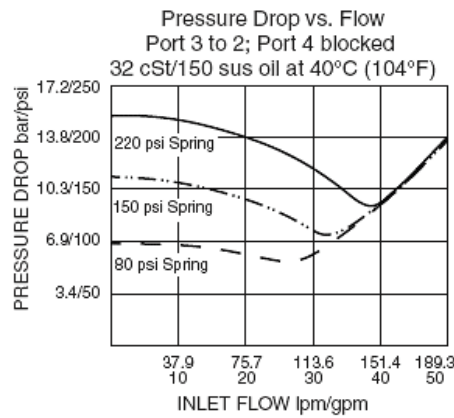
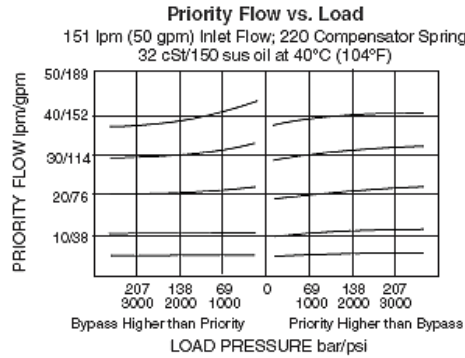

Dimensions

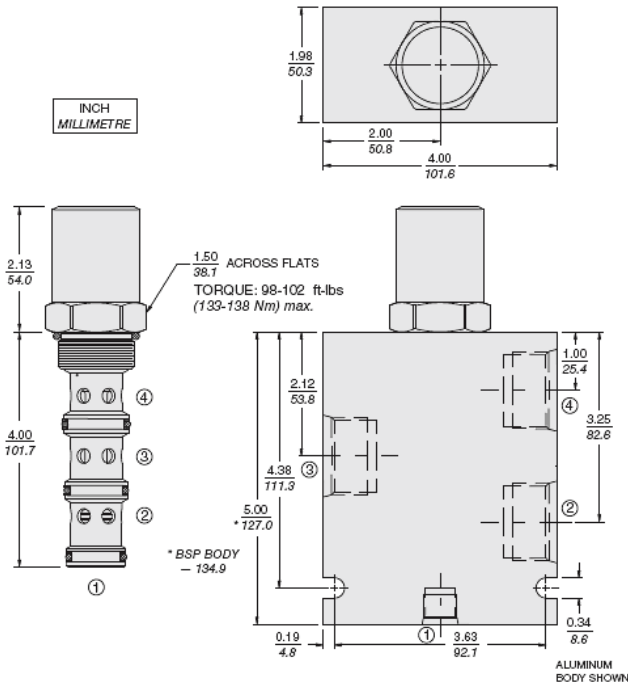

Installation Specifications

Cavity	VC16-4
Cartridge installation torque	133 to 138 N-m (98 to 102 ft-lb)
Orientation restriction	None



Accessories

Seal kit SK16-4X-MMM - **Note:** X = seal option
 SK10-4U-0 - **Note:** Urethane

Order Code

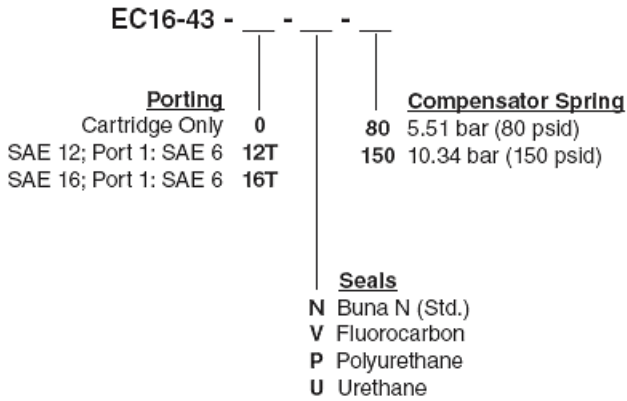

Model Options

EC16-43-H-J-R

H Line Body

CODE	DESCRIPTION
0	No Body
12TD	Ductile Iron SAE 12
16TD	Ductile Iron SAE 16

J Seal

CODE	DESCRIPTION
N	Buna-N
V	Fluorocarbon
P	Polyurethane
U	PPDI Urethane

R Compensator Spring

CODE	DESCRIPTION
80	80 Compensator Spring
150	150 Compensator Spring
220	220 Compensator Spring