

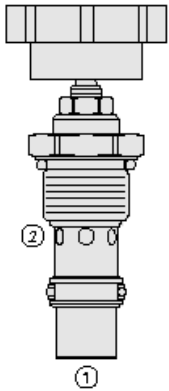

Overview



Description

FR12-23 is a screw-in, adjustable, pressure compensated, restrictive type with reverse flow check flow regulator cartridge valve.

Operation

The valve opening increases from fully closed to fully open with counterclockwise adjustment rotation. With inlet at port 1 the FR12-23X valve will maintain preset flow rate from port 2 regardless of pressure variations in the circuit. The valve is intended for use with mineral based or synthetic fluids with lubricating properties.

Features

- Hardened parts for long life.
- Quiet, modulated response.
- Cost-effective cavity.

Symbol

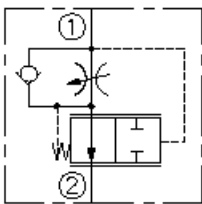

Ratings

Pressure Ratings

Pressure rating	241 bar (3500 psi)
Proof pressure	345 bar (5000 psi)
Burst pressure	896 bar (13000 psi)

Flow Ratings

Flow rating	75.7 lpm (20 gpm)
Maximum internal leakage	0.12 lpm (0.03 gpm) - Note: 1 to 2 max fully closed

Temperature Ratings

Operating fluid temperature	-40 to 100 °C (-40 to 212 °F)	- Note: With buna N seals
	-26 to 204 °C (-15 to 400 °F)	- Note: With viton seals
	-54 to 107 °C (-65 to 225 °F)	- Note: With polyurethane seals
Storage temperature	-40 to 70 °C (-40 to 160 °F)	
Ambient temperature	-40 to 70 °C (-40 to 160 °F)	

Other Ratings

Corrosion protection	960 hr salt spray per ASTM b117 (model number gfr12-23)
----------------------	---

Operating Parameters

Fluids	Mineral based or synthetic hydraulic fluid with lubricating properties
Fluid viscosity range	7.4 to 420 cSt
Maximum operating contamination level	18/16/13 per ISO 4406

Properties

Unit weight	0.21 kg (0.48 lb)	- Note: FR12-23A
	0.24 kg (0.52 lb)	- Note: FR12-23C
	0.25 kg (0.55 lb)	- Note: FR12-23E
	0.22 kg (0.49 lb)	- Note: FR12-23 (blank)
Internal wetted surface area	204 cm ² (31.64 in ²)	



Performance

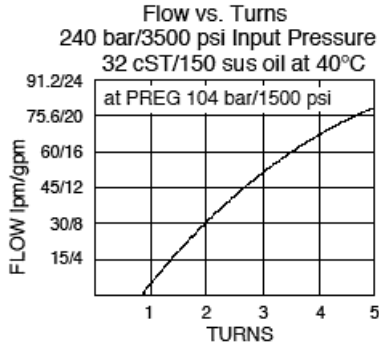
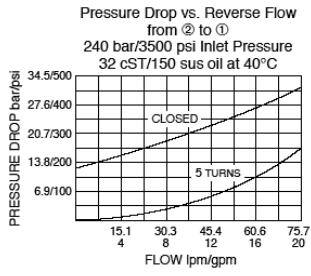
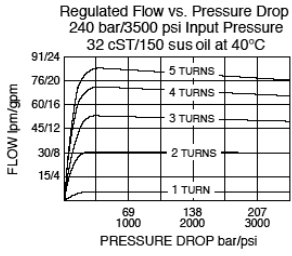

Dimensions

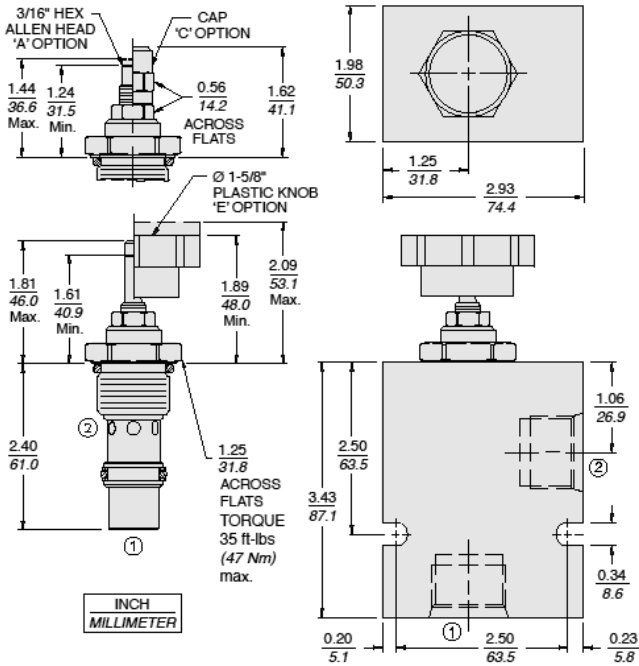

Installation Specifications

Cavity	VC12-2B
Cartridge installation torque	45 to 50 N-m (33 to 37 ft-lb)
Cover cap torque	7 to 10 N-m (5 to 7 ft-lb)
Orientation restriction	None

Accessories

Seal kit	SK12-2X-M	- Note: X = seal option
----------	-----------	-------------------------



Order Code

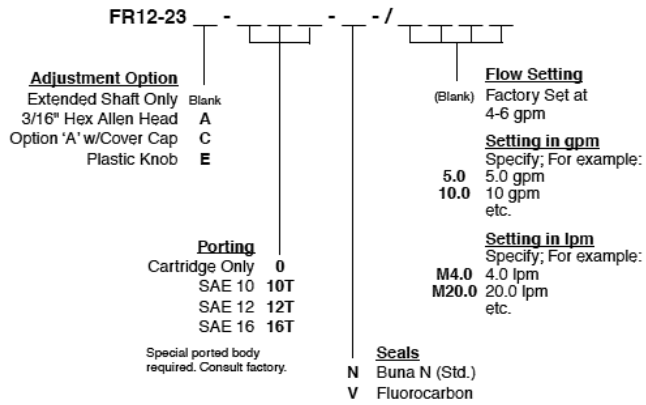

Model Options

FR12-23F-H-J-/T

F Adjustment Option

CODE	DESCRIPTION
A	3/16" Hex Allen Head
BLANK	Extended Shaft Only
C	3/16" Hex Allen Head with Cover Cap
E	Plastic Knob

H Line Body

CODE	DESCRIPTION
0	No Body
10T	Aluminum SAE 10
12T	Aluminum SAE 12

J Seal

CODE	DESCRIPTION
N	Buna-N
V	Fluorocarbon
P	Polyurethane
U	PPDI Urethane

T Flow setting

CODE	DESCRIPTION
XX	Flow setting