

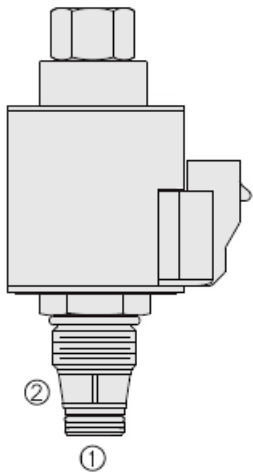

Overview



Description

A solenoid-operated, 2-port, normally open, poppet-type, proportional, screw-in hydraulic cartridge valve, designed for low leakage blocking and load-holding applications.

Operation

When energized, the SP10-21 acts as a check valve, allowing flow from 1 to 2, while blocking flow from 2 to 1. When de-energized, the poppet lifts to open the 2 to 1 flow path.

Features

- Continuous-duty rated coil.
- Efficient wet-armature construction.
- Optional waterproof E-Coils rated up to IP69K.
- Industry common cavity.

Symbol

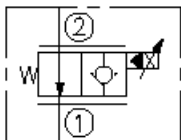

Ratings

Pressure Ratings

Pressure rating 250 bar (3625 psi)

Flow Ratings

Maximum internal leakage 5 drops/min - **Note:** At nominal voltage to coil 207 bar (3000 psi)

Temperature Ratings

Operating fluid temperature	-40 to 100 °C (-40 to 212 °F)	- Note: With buna N seals
	-26 to 204 °C (-15 to 400 °F)	- Note: With fluorocarbon seals
	-54 to 107 °C (-65 to 225 °F)	- Note: With polyurethane seals
Storage temperature	-40 to 70 °C (-40 to 160 °F)	
Ambient temperature	-40 to 90 °C (-40 to 194 °F)	

Other Ratings

Corrosion protection 960 hr salt spray per ASTM b117

Operating Parameters

Fluids	Mineral based or synthetic hydraulic fluid with lubricating properties
Fluid viscosity range	7.4 to 420 cSt
Maximum operating contamination level	20/18/1 per ISO 4406

Properties

Materials	Steel with hardened work surfaces zinc-plated exposed surfaces
Unit weight	0.17 kg (0.37 lb) 0.59 kg (1.30 lb) - Note: Including e-coil
Internal wetted surface area	176 cm ² (27.24 in ²)



Electrical Parameters

Minimum operating PWM dither frequency 70 Hz

Performance

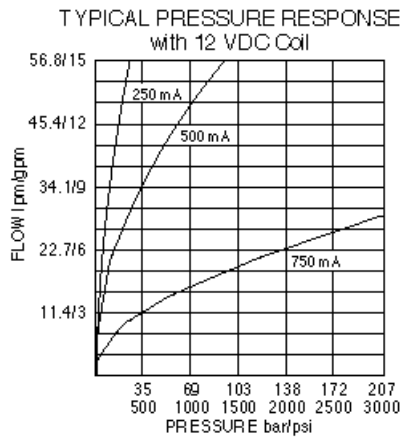
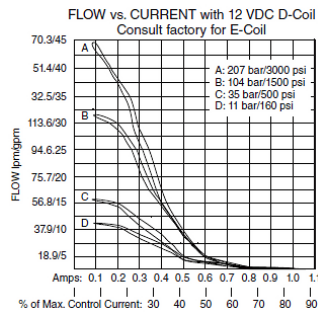
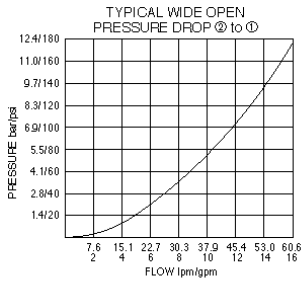

Dimensions

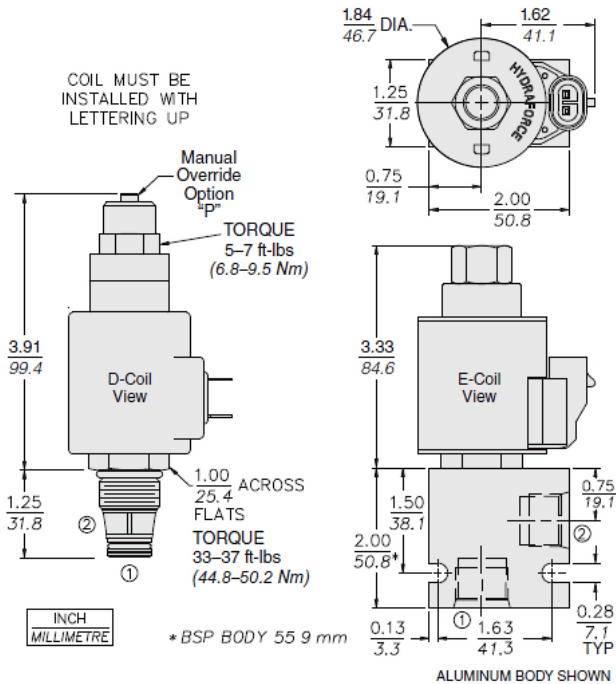

Installation Specifications

Cavity	VC10-2
Cartridge installation torque	44.8 to 50.2 N-m (33 to 37 ft-lb)
Maximum allowable torque	6.8 to 9.5 N-m (50 ft-lb)
Coil nut torque	6.8 to 9.5 N-m (5 to 7 ft-lb)
Orientation restriction	None

Accessories

Seal kit	SK10-2X-T
----------	-----------

Order Code

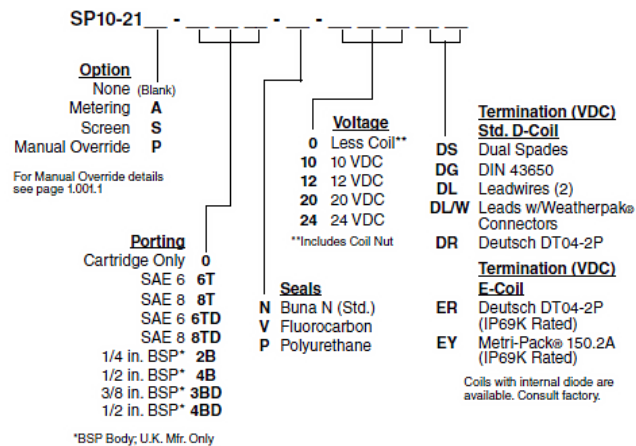

*BSP Body; U.K. Mfr. Only

Model Options

SP10-21DEG-H-J-L

D Poppet Metering

CODE	DESCRIPTION
A	Linear Poppet Metering
BLANK	Standard Poppet Metering

E Manual Override

CODE	DESCRIPTION
BLANK	NONE
K	Momentary Push Override, Knob
P	Momentary Push Override, Button

G Screen

CODE	DESCRIPTION
BLANK	NONE
S	100 Mesh Screen

H Line Body

CODE	DESCRIPTION
0	No Body
6T	Aluminum SAE 6
8T	Aluminum SAE 8
6TD	Ductile Iron SAE 6
8TD	Ductile Iron SAE 8
2B	Aluminum BSPP 1/4" (2)
3B	Aluminum BSPP 3/8" (3)
4B	Aluminum BSPP 1/2" (4)
4BD	Ductile Iron BSPP 1/2" (4)

J Seal

CODE	DESCRIPTION
N	Buna-N
V	Fluorocarbon
P	Polyurethane
U	PPDI Urethane



L Coil

CODE	DESCRIPTION
0	No Coil
10DG	10 VDC, D-Coil, DIN 43650
10DL	10 VDC, D-Coil, Dual Lead Wires
10DS	10 VDC, D-Coil, Dual Spade
10EL	10 VDC, E-Coil, Dual Lead Wires
10ER	10 VDC, E-Coil, Deutsch
12DG	12 VDC, D-Coil, DIN 43650
12DL	12 VDC, D-Coil, Dual Lead Wires, 18 inches long
12DL/36	12 VDC, D-Coil, Dual Lead Wires, 36 inches long
12DL/W	12 VDC, D-Coil, Dual Lead Wires with Weatherpak
12DR	12 VDC, D-Coil, Deutsch
12DS	12 VDC, D-Coil, Dual Spade
12EG	12 VDC, E-Coil, DIN 43650
12EJ	12 VDC, E-Coil, AMP Jr.
12EL	12 VDC, E-Coil, Dual Lead Wires, 18 inches long
12EL/36	12 VDC, E-Coil, Dual Lead Wires, 36 inches long
12ER	12 VDC, E-Coil, Deutsch
12EY	12 VDC, E-Coil, Metri-Pack 150
20DS	20 VDC, D-Coil, Dual Spade
20ER	20 VDC, E-Coil, Deutsch
24AG	24 VDC, D-Coil, DIN 43650
24AP	24 VDC, D-Coil, 1/2" Conduit and Dual Lead Wires
24DG	24 VDC, D-Coil, DIN 43650
24DL	24 VDC, D-Coil, Dual Lead Wires
24DL/W	24 VDC, D-Coil, Dual Lead Wires with Weatherpak
24DP	24 VDC, D-Coil, 1/2" Conduit and Dual Lead Wires
24DR	24 VDC, D-Coil, Deutsch
24DS	24 VDC, D-Coil, Dual Spade
24EG	24 VDC, E-Coil, DIN 43650
24EJ	24 VDC, E-Coil, AMP Jr.
24EL	24 VDC, E-Coil, Dual Lead Wires, 18 inches long
24EL/36	24 VDC, E-Coil, Dual Lead Wires, 36 inches long
24ER	24 VDC, E-Coil, Deutsch
24EY	24 VDC, E-Coil, Metri-Pack 150
36DS	36 VDC, D-Coil, Dual Spade