

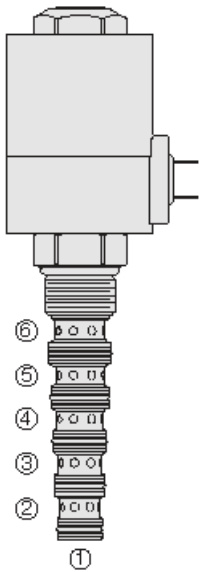

## Overview



### Description

A solenoid-operated, 2 position, 6 way, direct-acting spool-type, screw-in hydraulic cartridge valve. It is intended for use as a selector valve in selector or series/parallel drive circuits. When de-energized, the SV12-60X allows bidirectional flow between port 5 and port 6, and between port 1 and port 2, while blocking flow at port 3 and port 4. When energized, the spool shifts to allow bidirectional flow between port 4 and port 5 and between port 3 and port 2, while blocking flow at port 1 and port 6.

### Features

- Bi-directional flow.
- Hardened precision spool and cage for long life.
- Optional coil voltages and terminations.
- All ports may be fully pressurized.
- Heavy-duty waterproof coils rated up to IP69K.
- External metal-shell coil design.

### Symbol

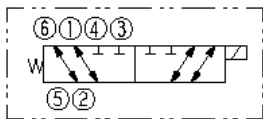

## Ratings

### Pressure Ratings

Pressure rating	240 bar (3500 psi)
Proof pressure	483 bar (7000 psi)
Burst pressure	690 bar (10000 psi)

### Flow Ratings

Flow rating	- <b>Note:</b> See table (sheet 3) for specific circuit type	
Maximum internal leakage	295 ml/min (18 in <sup>3</sup> /min)	- <b>Note:</b> Max at 240 bar (3500 psi)

### Temperature Ratings

Operating fluid temperature	-40 to 100 °C (-40 to 212 °F)	- <b>Note:</b> With buna N seals
	-26 to 204 °C (-15 to 400 °F)	- <b>Note:</b> With viton seals
Storage temperature	-40 to 70 °C (-40 to 160 °F)	
Ambient temperature	-40 to 70 °C (-40 to 160 °F)	

### Other Ratings

Cycle life	1 million cycles at rated pressure and flow	
Response	135 ms	- <b>Note:</b> Pull-in, indication of shift with nominal voltage
	30 ms	- <b>Note:</b> Drop-out, indication of shift with nominal voltage
	140 ms	- <b>Note:</b> Pull-in, per NFPA/T3.5.30-19XX
	60 ms	- <b>Note:</b> Drop-out, per NFPA/T3.5.30-19XX
Environmental rating	Ip67 (with integral connectors)	

## Operating Parameters

Fluids	Mineral based or synthetic hydraulic fluid with lubricating properties
Fluid viscosity range	7.4 to 420 cSt
Maximum operating contamination level	20/18/14 per ISO 4406



## Properties

Unit weight	0.54 kg (1.20 lb)
Internal wetted surface area	423 cm <sup>2</sup> (65.6 in <sup>2</sup> )

## Performance

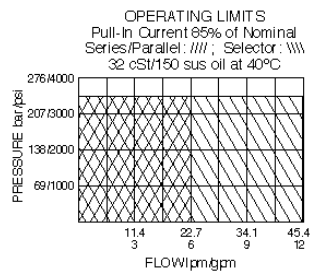
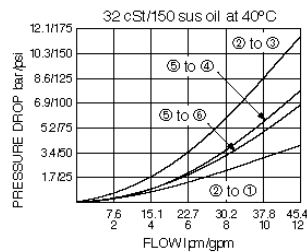

CONTINUOUS DUTY OPERATING RANGE  
Minimum Voltage at the Coil Required for Pull-In  
32 cSt/150 ssu oil at 40°C

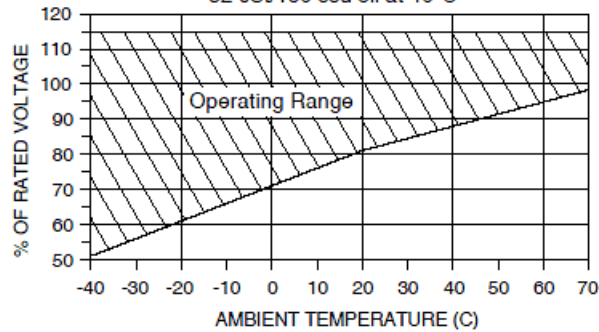

## Dimensions

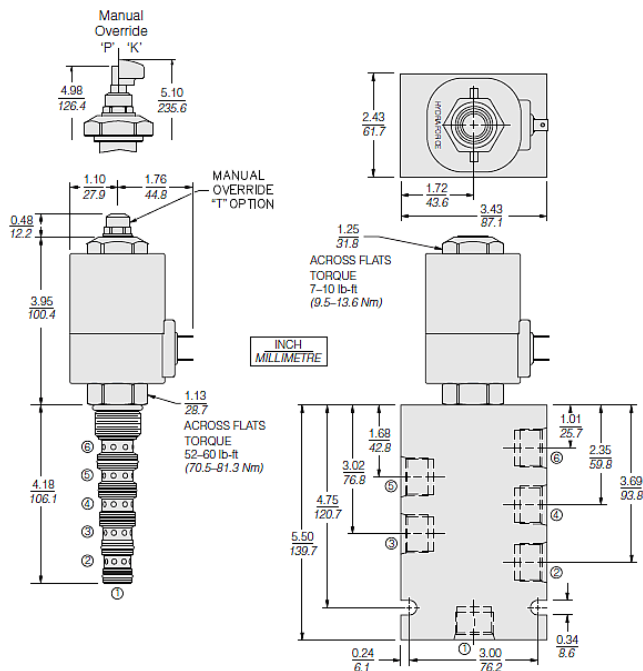

## Installation Specifications

Cavity	VC12-6
Cartridge installation torque	70.5 to 81.4 N-m (52 to 60 ft-lb)
Maximum allowable torque	122 N-m (90 ft-lb)
Coil nut torque	9.5 to 13.6 N-m (7 to 10 ft-lb)
Orientation restriction	None

## Accessories

Seal kit	SK12-6X-MMMMM	- Note: X = seal option
----------	---------------	-------------------------



## Order Code

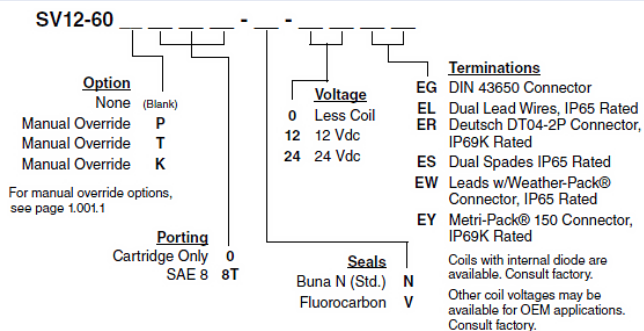

## Model Options

### SV12-60E-H-J-L

#### E Manual Override

CODE	DESCRIPTION
BLANK	NONE
K	Momentary Push Override, Knob
P	Momentary Push Override, Button
T	Variable Position Override, Slotted Screw

#### H Line Body

CODE	DESCRIPTION
0	No Body
8T	Aluminum SAE 8
10T	Aluminum SAE 10

#### J Seal

CODE	DESCRIPTION
N	Buna-N
V	Fluorocarbon
P	Polyurethane
U	PPDI Urethane

#### L Coil

CODE	DESCRIPTION
0	No Coil
12EG	12 VDC, E-Coil, DIN 43650
12EL	12 VDC, E-Coil, Dual Lead Wires
12EL/W	12 VDC, E-Coil, Dual Lead Wires with WeatherPak
12ER	12 VDC, E-Coil, Deutsch
12ER/Z	12 VDC, E-Coil, Deutsch with Zener Diode
12ES	12 VDC, E-Coil, Dual Spade
12EY	12 VDC, E-Coil, Metri-Pack 150
24EG	24 VDC, E-Coil, DIN 43650
24ER	24 VDC, E-Coil, Deutsch
24ER/Z	24 VDC, E-Coil, Deutsch with Zener Diode
24ES	24 VDC, E-Coil, Dual Spade