

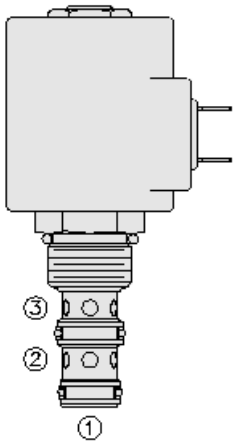

Overview



Description

A solenoid operated, 3 port, direct acting, spool type, screw-in hydraulic cartridge valve.

Operation

When de-energized, the SV10-33 allows flow from port 3 to port 1, while blocking flow at port 2. When energized, the cartridges spool shifts from port 1 to port 2, while blocking at port 3. Except under low flow conditions, inlet flow source at port 1 is not recommended.

Features

- Continuous-duty rated coil.
- Hardened precision spool and cage for long life.
- Optional coil voltages and terminations.
- Efficient wet-armature construction.
- Cartridges are voltage interchangeable.
- All ports may be fully pressurized.
- Unitized, molded coil design.
- Manual override option.
- Optional waterproof E-Coils rated up to IP69K.
- Industry common cavity.

Symbol

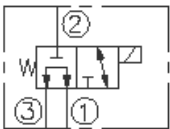

Ratings

Pressure Ratings

Pressure rating	207 bar (3000 psi)
Proof pressure	350 bar (5075 psi)

Flow Ratings

Flow rating	18.9 lpm (5 gpm)	- Note: Maximum, see chart
Maximum internal leakage	5 in ³ /min	- Note: Max at 207 bar (3000 psi)

Temperature Ratings

Operating fluid temperature	-40 to 120 °C (-40 to 250 °F)	- Note: With buna N seals
	-30 to 205 °C (-20 to 400 °F)	- Note: With fluorocarbon seals

Properties

Materials	steel with hardened work surfaces zinc-plated exposed
-----------	---

Performance

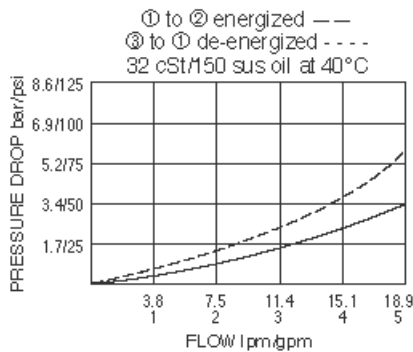



Dimensions

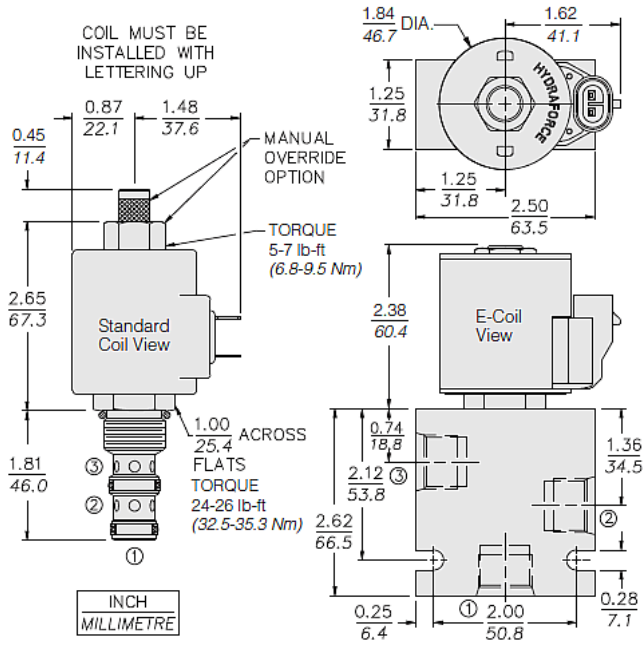

Installation Specifications

Cavity	VC10-3
Cartridge installation torque	32.5 to 35.3 N-m (24 to 26 ft-lb)
Coil nut torque	6.8 to 9.5 N-m (5 to 7 ft-lb)

Accessories

Seal kit	SK10-3X-MM
----------	------------

Order Code

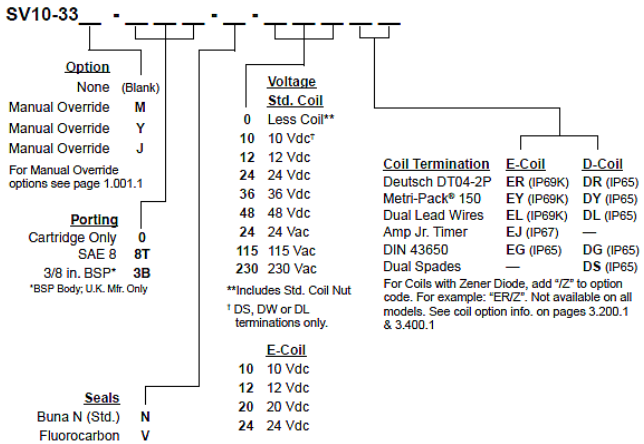

Model Options

SV10-33E-H-J-L

E Manual Override

CODE	DESCRIPTION
BLANK	NONE
J	Momentary Pull Override, #10-32 threads
M	Two Position Override, Red Knurled Knob
Y	Momentary Pull Override, Red Knurled Knob

H Line Body



CODE	DESCRIPTION
0	No Body
6T	Aluminum SAE 6
8T	Aluminum SAE 8
6TD	Ductile Iron SAE 6
8TD	Ductile Iron SAE 8
3B	Aluminum BSPP 3/8" (3)
3BD	Ductile Iron BSPP 3/8" (3)

J Seal

CODE	DESCRIPTION
N	Buna-N
V	Fluorocarbon
P	Polyurethane
U	PPDI Urethane

L Coil

CODE	DESCRIPTION
0	No Coil
10DG	10 VDC, D-Coil, DIN 43650
10DL	10 VDC, D-Coil, Dual Lead Wires
10DR/D	10 VDC, D-Coil, Deutsch with Diode
10DS	10 VDC, D-Coil, Dual Spade
10EL	10 VDC, E-Coil, Dual Lead Wires
10ER	10 VDC, E-Coil, Deutsch
10ER/Z	10 VDC, E-Coil, Deutsch with Zener Diode
12DG	12 VDC, D-Coil, DIN 43650
12DL	12 VDC, D-Coil, Dual Lead Wires, 18 inches long
12DL/36	12 VDC, D-Coil, Dual Lead Wires, 36 inches long
12DL/W	12 VDC, D-Coil, Dual Lead Wires with Weatherpak
12DL/W/D	12 VDC, D-Coil, Dual Lead Wires with Weatherpak with Diode
12DR	12 VDC, D-Coil, Deutsch
12DR/D	12 VDC, D-Coil, Deutsch with Diode
12DR/Z	12 VDC, D-Coil, Deutsch with Zener Diode
12DS	12 VDC, D-Coil, Dual Spade
12EG	12 VDC, E-Coil, DIN 43650
12EJ	12 VDC, E-Coil, AMP Jr.
12EL	12 VDC, E-Coil, Dual Lead Wires, 18 inches long
12EL/36	12 VDC, E-Coil, Dual Lead Wires, 36 inches long
12EL/W/Z	12 VDC, E-Coil, Dual Lead Wires with WeatherPak and Zener Diode
12EL/Z	12 VDC, E-Coil, Dual Lead Wires with Zener Diode
12ER	12 VDC, E-Coil, Deutsch
12ER/Z	12 VDC, E-Coil, Deutsch with Zener Diode
12EY	12 VDC, E-Coil, Metri-Pack 150
12EY/Z	12 VDC, E-Coil, Metri-Pack 150 with Zener Diode



CODE	DESCRIPTION
20DR/D	20 VDC, D-Coil, Deutsch with Diode
20DS	20 VDC, D-Coil, Dual Spade
20ER	20 VDC, E-Coil, Deutsch
24AG	24 VDC, D-Coil, DIN 43650
24AP	24 VDC, D-Coil, 1/2" Conduit and Dual Lead Wires
24DG	24 VDC, D-Coil, DIN 43650
24DL	24 VDC, D-Coil, Dual Lead Wires
24DL/W	24 VDC, D-Coil, Dual Lead Wires with Weatherpak
24DL/W/D	24 VDC, D-Coil, Dual Lead Wires with Weatherpak with Diode
24DP	24 VDC, D-Coil, 1/2" Conduit and Dual Lead Wires
24DR	24 VDC, D-Coil, Deutsch
24DR/D	24 VDC, D-Coil, Deutsch with Diode
24DS	24 VDC, D-Coil, Dual Spade
24EG	24 VDC, E-Coil, DIN 43650
24EJ	24 VDC, E-Coil, AMP Jr.
24EL	24 VDC, E-Coil, Dual Lead Wires, 18 inches long
24EL/36	24 VDC, E-Coil, Dual Lead Wires, 36 inches long
24EL/W/Z	24 VDC, E-Coil, Dual Lead Wires with WeatherPak and Zener Diode
24ER	24 VDC, E-Coil, Deutsch
24ER/Z	24 VDC, E-Coil, Deutsch with Zener Diode
24EY	24 VDC, E-Coil, Metri-Pack 150
24EY/Z	24 VDC, E-Coil, Metri-Pack 150 with Zener Diode
36DS	36 VDC, D-Coil, Dual Spade
115AG	115 VAC, D-Coil, DIN 43650
115AP	115 VAC, D-Coil, 1/2" Conduit and Dual Lead Wires
230AG	230 VAC, D-Coil, DIN 43650
230AP	230 VAC, D-Coil, 1/2" Conduit and Dual Lead Wires