

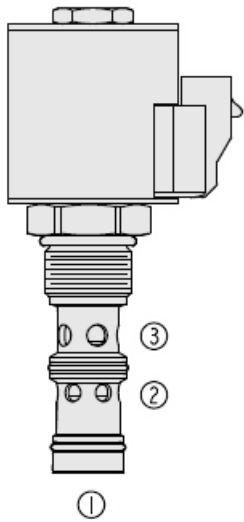

Overview



Description

A proportional solenoid-operated, 3-way, normally closed flow control, screw-in hydraulic cartridge valve intended for post-compensated applications with load sense systems. In post-compensated systems the load sense (port 1) of each HSPec12-32 valve is connected to highest load which maintains flow sharing when flow demand exceeds flow supply. Pressure compensation value of the valve defined as pressure difference between inlet and load sense ports is provided by appropriate setup of a pump load sense control or by additional pressure compensator valve, one for the whole system, in case if the pump is non-adjustable.

Operation

When de-energized, the HSPec12-32XX blocks flow from port 3 to port 2. The valve will regulate flow out of port 2 regardless of load pressure with flow rate proportional to current applied to the solenoid.

Features

- Integral post-compensator.
- Integral load-sense.
- Reduced manifold space claim.
- Continuous-duty rated coils.
- Optional "A" type linear metering poppet.
- Manual override option.
- E-Coils rated up to IP69K.
- Flow sharing possible
- All HyPerformance[®] valves are tested to the rigorous standards of NFPA specification T2.6.1 and are tested at a verification level of 90% and an assurance of 99%

Symbol

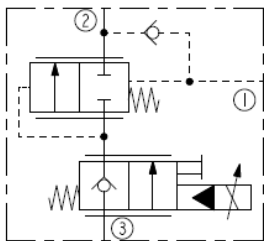

Ratings

Pressure Ratings

Pressure rating	350 bar (5075 psi) 420 bar (6090 psi)	- Note: 10% cycle life
Proof pressure	690 bar (10000 psi)	
Burst pressure	1380 bar (20000 psi)	

Flow Ratings

Flow rating	56.8 lpm (15.0 gpm)	- Note: HSPec12-32/32T (at compensation value 11 bar (160 psi))
	68.1 lpm (18.0 gpm)	- Note: HSPec12-32A/32AT (at compensation value 11 bar (160 psi))
Maximum internal leakage	7 drops/min	- Note: Port 3 to 2 or port 1 to 2 with 350 bar (5075 psi) at port 3 or 1

Temperature Ratings

Operating fluid temperature	-40 to 100 °C (-40 to 212 °F)	- Note: With buna N seals
	-26 to 204 °C (-15 to 400 °F)	- Note: With fluorocarbon seals
	-54 to 107 °C (-65 to 225 °F)	- Note: With urethane seals
Storage temperature	-40 to 70 °C (-40 to 160 °F)	
Ambient temperature	-40 to 70 °C (-40 to 160 °F)	

Operating Parameters

Fluids	Mineral based or synthetic hydraulic fluid with lubricating properties
Fluid viscosity range	7.4 to 420 cSt
Maximum operating contamination level	18/16/13 per ISO 4406



Properties

Unit weight	0.32 kg (0.70 lb) 0.33 kg (0.72 lb)	- Note: HSPEC12-32X without coil and nut - Note: HSPEC12-32XT without coil and nut
Internal wetted surface area	267.3 cm ² (41.43 in ²) 274.2 cm ² (42.5 in ²)	- Note: HSPEC12-32X - Note: HSPEC12-32XT

Performance

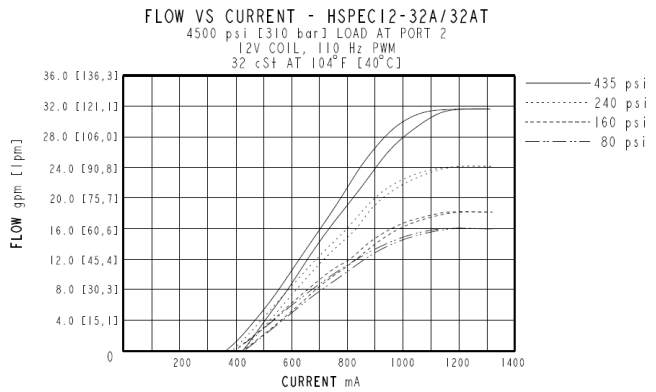
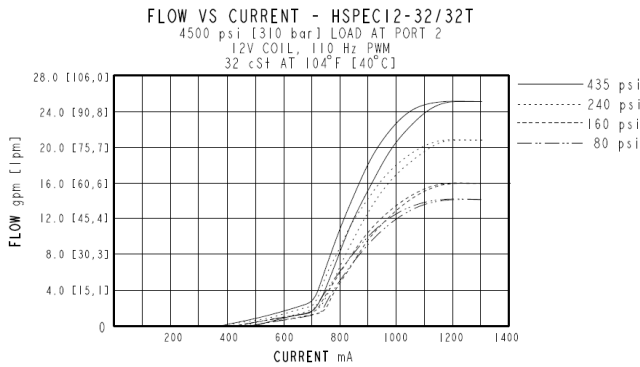
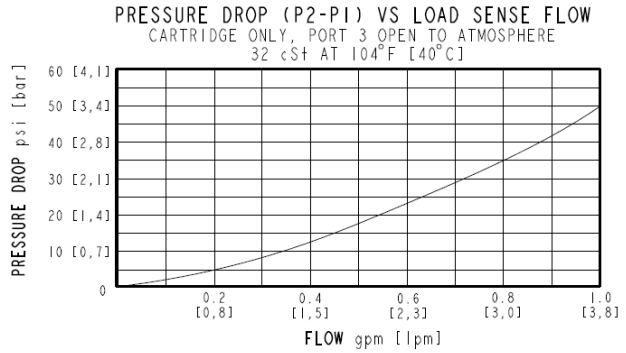
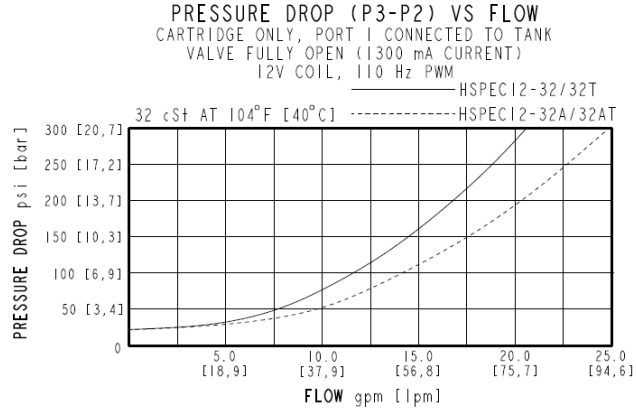

Dimensions

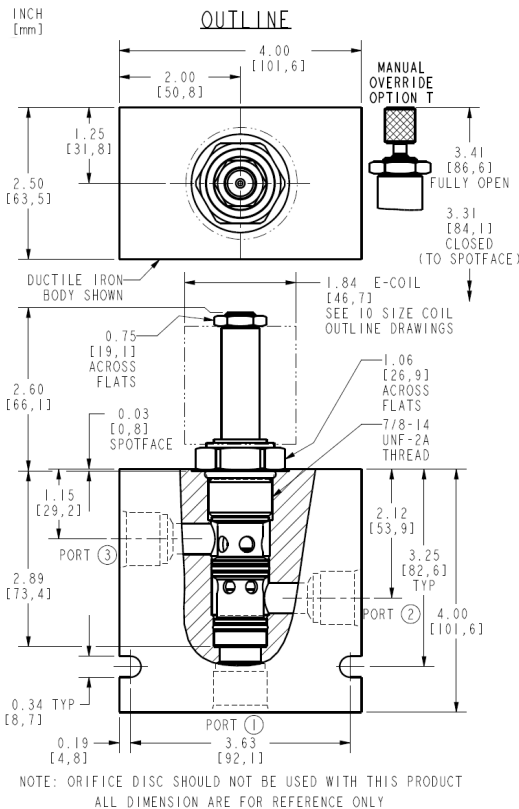



Installation Specifications

Cavity	HVC12-3	
Cartridge installation torque	156 to 170 N-m (115 to 125 ft-lb) 122 to 136 N-m (90 to 100 ft-lb)	- Note: Steel/ductile iron cavity - Note: Aluminum cavity
Coil nut torque	7 to 10 N-m (5 to 7 ft-lb)	
Orientation restriction	None	

Accessories

Seal kit	SK12-3N-MM SK12-3V-MM SK12-3U-OO	- Note: Buna N - Note: Fluorocarbon - Note: Urethane
Housings		
Coils		

Order Code

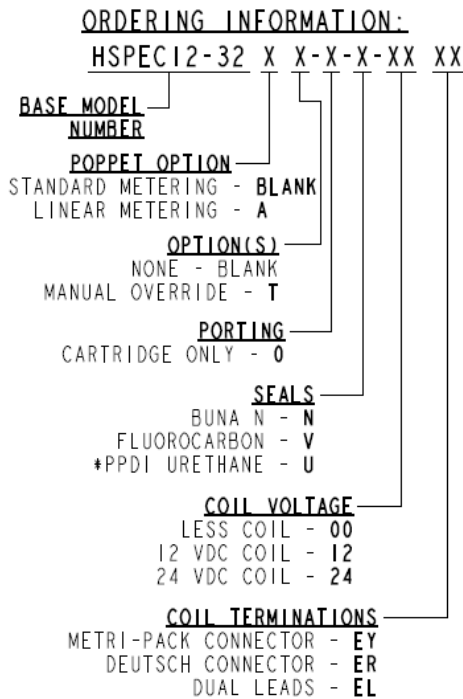

* URETHANE SEALS RECOMMENDED FOR OPERATING PRESSURES ABOVE 3500 psi [241 bar]

POSITION	CODE	DESCRIPTION
		HSPEC12-32DE-H-J-L
D		Poppet Metering
D	A	Linear Poppet Metering
D	BLANK	Standard Poppet Metering
E		Manual Override
E	BLANK	NONE
E	T	Variable Position Override, Red Knurled Knob
H		Line Body
H	0	No Body
H	16HT	Ductile Iron SAE 16
J		Seal
J	N	Buna-N
J	V	Fluorocarbon



POSITION	CODE	DESCRIPTION
J	U	PPDI Urethane
L		Coil
L	0	No Coil
L	10EL	10 VDC, E-Coil, Dual Lead Wires
L	10ER	10 VDC, E-Coil, Deutsch
L	12EG	12 VDC, E-Coil, DIN 43650
L	12EJ	12 VDC, E-Coil, AMP Jr.
L	12EL	12 VDC, E-Coil, Dual Lead Wires, 18 inches long
L	12EL/36	12 VDC, E-Coil, Dual Lead Wires, 36 inches long
L	12ER	12 VDC, E-Coil, Deutsch
L	12EY	12 VDC, E-Coil, Metri-Pack 150
L	20ER	20 VDC, E-Coil, Deutsch
L	24EG	24 VDC, E-Coil, DIN 43650
L	24EJ	24 VDC, E-Coil, AMP Jr.
L	24EL	24 VDC, E-Coil, Dual Lead Wires, 18 inches long
L	24EL/36	24 VDC, E-Coil, Dual Lead Wires, 36 inches long
L	24ER	24 VDC, E-Coil, Deutsch
L	24EY	24 VDC, E-Coil, Metri-Pack 150