

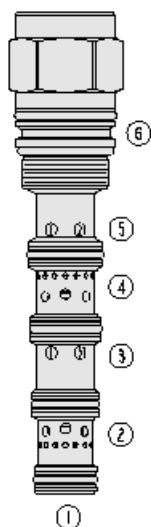

Overview



Description

The PE16-S67D is a screw-in, cartridge-style, proportional, spring centered spool type, pilot operated hydraulic directional valve.

Operation

In neutral position inlet port 3 is blocked and ports 2, 4 and 5 are communicating with each other. On remote pilot signal at port 1 the valve's spool shifts proportionally to the applied pilot pressure to allow flow from port 3 to port 4, thru a load, such as hydraulic cylinder or motor, and then from port 2 to port 5 and to tank. On remote pilot signal at port 6 the valve's spool shifts proportionally to the applied pressure in opposite direction thus reversing the flow direction. The valve's spool is symmetrical providing meter-in and meter-out control.

Features

- Hardened spool and cage for long life.
- Excellent metering characteristics.
- Good Linearity.

Symbol

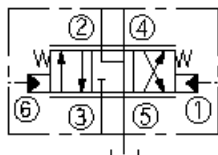

Ratings

Pressure Ratings

Pressure rating	345 bar (5000 psi)	- Note: Port 3
	241 bar (3500 psi)	- Note: Ports 2, 4
	27.6 bar (400 psi)	- Note: Ports 1, 6

Flow Ratings

Flow rating	90.8 lpm (24 gpm)	
Maximum internal leakage	197 ml/min (12 in ³ /min)	- Note: At 207 bar (3000 psi)

Temperature Ratings

Operating fluid temperature	-40 to 100 °C (-40 to 212 °F)	- Note: With buna N seals
	-26 to 204 °C (-15 to 400 °F)	- Note: With fluorocarbon seals
	-54 to 107 °C (-65 to 225 °F)	- Note: With polyurethane seals
Storage temperature	-40 to 70 °C (-40 to 160 °F)	
Ambient temperature	-40 to 90 °C (-40 to 194 °F)	

Operating Parameters

Fluids	Mineral based or synthetic hydraulic fluid with lubricating properties
Fluid viscosity range	7.4 to 420 cSt
Maximum operating contamination level	18/16/13 per ISO 4406

Properties

Displacement per stroke	1.14 cm ³ (0.069 in ³)	- Note: per stroke direction
Unit weight	0.78 kg (1.7 lb)	
Internal wetted surface area	597 cm ² (92.5 in ²)	



Performance

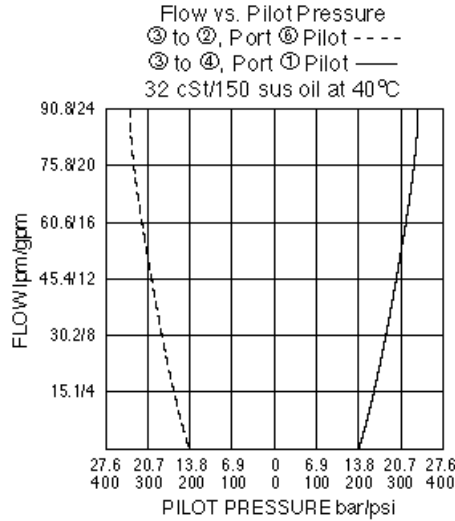
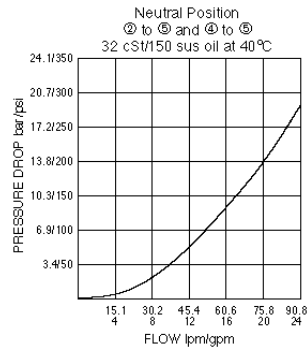
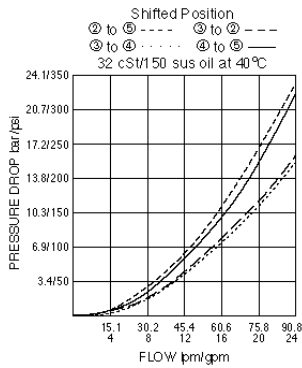

Dimensions

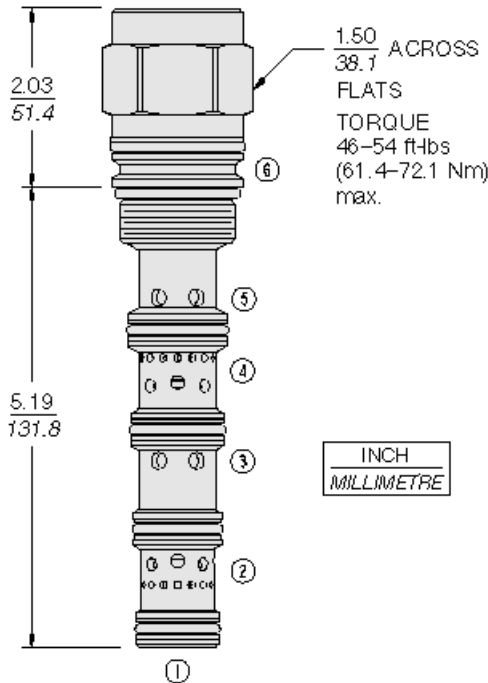

Installation Specifications

Cavity	VC16-S6
Cartridge installation torque	62.4 to 73.2 N-m (46 to 54 ft-lb)
Maximum allowable torque	94.9 N-m (70 ft-lb)
Orientation restriction	None

Accessories

Seal kit	SK16-S6X-BMMMM	- Note: X = seal option
Housings		



Order Code

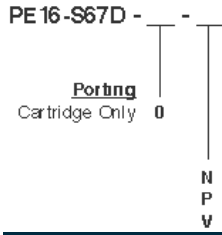

POSITION	CODE	DESCRIPTION
		PE16-S67D-H-J
H		Line Body
H	0	No Body
J		Seal
J	N	Buna-N
J	V	Fluorocarbon
J	P	Polyurethane
J	U	PPDI Urethane