

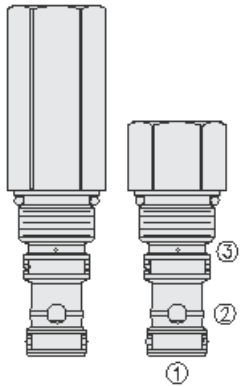

Overview



Description

The EP10-S36X is a screw-in, cartridge style, pilot to close, internally damped, hydraulic directional logic element.

Operation

The valve is a spring-biased blocking valve which will shift to allow full flow from port 1 to 2 only when the pressure at port 1 exceeds the cumulative pressure of port 3 plus the bias spring pressure value. Port 1 is internally connected to port 3 through a damping chamber which allows annular leakage flow to port 3.

Features

- Internally damped for improved stability
- Staggered hole cage for improved resolution
- Chrome silicon springs offer consistent performance at high temperatures
- Use as a pressure control or compensating element

Symbol

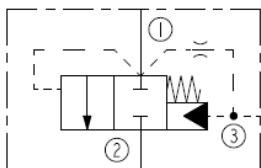

Ratings

Pressure Ratings

Pressure rating 345 bar (5000 psi)

Flow Ratings

Flow rating See performance graph

Maximum internal leakage 164 ml/min (10 in³/min) - **Note:** At 207 bar (3000 psi) See graph for port 1 to port 3 leakage

Temperature Ratings

Operating fluid temperature	-40 to 100 °C (-40 to 212 °F)	- Note: With buna N seals
	-26 to 204 °C (-15 to 400 °F)	- Note: With fluorocarbon seals
	-54 to 107 °C (-65 to 225 °F)	- Note: With polyurethane seals
Storage temperature	-40 to 70 °C (-40 to 160 °F)	
Ambient temperature	-40 to 90 °C (-40 to 194 °F)	

Operating Parameters

Fluids	Mineral based or synthetic hydraulic fluid with lubricating properties	
Fluid viscosity range	7.4 to 420 cSt	
Maximum operating contamination level	20/18/14 per ISO 4406	

Properties

Unit weight	0.14 kg (0.31 lb)	- Note: EP10-S36
	0.28 kg (0.61 lb)	- Note: EP10-S36T
Internal wetted surface area	127 cm ² (19.7 in ²)	- Note: EP10-S36
	195 cm ² (30.2 in ²)	- Note: EP10-S36T



Performance

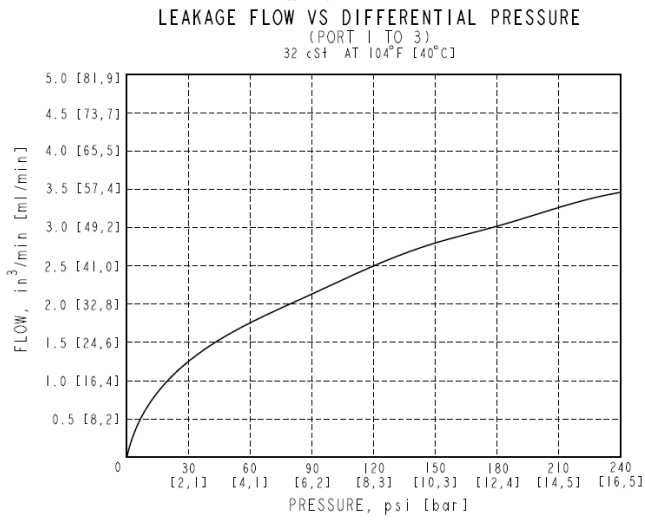
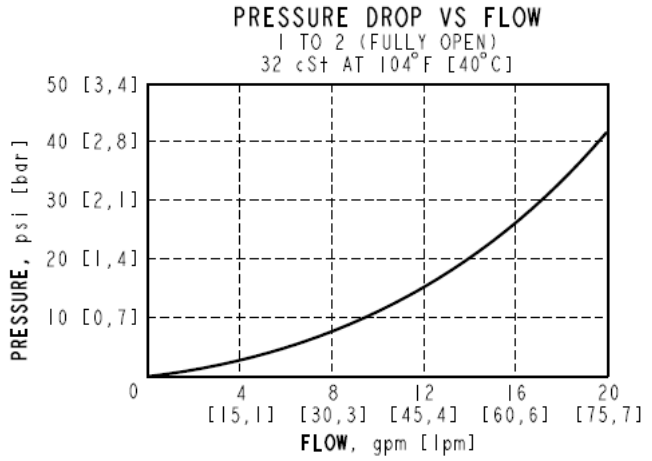
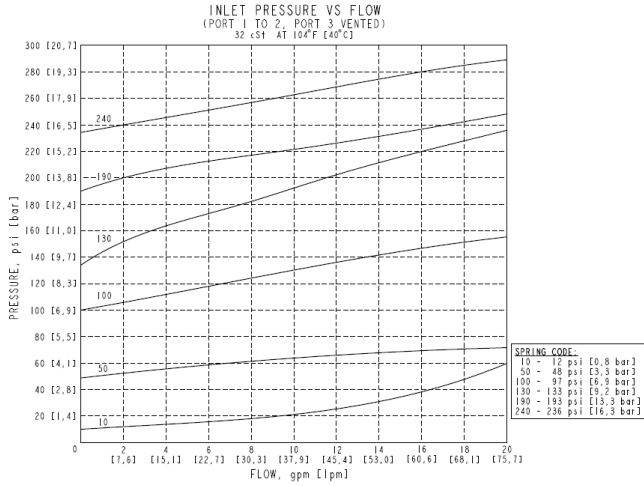

Dimensions

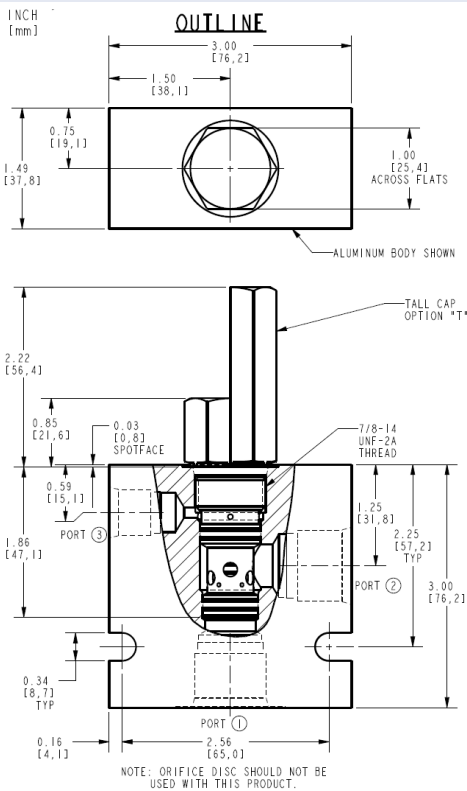

ALL DIMENSIONS ARE FOR REFERENCE ONLY



Installation Specifications

Cavity	VC10-S3
Cartridge installation torque	32.5 to 35.3 N-m (24 to 26 ft-lb)
Maximum allowable torque	67.8 N-m (50 ft-lb)
Orientation restriction	None

Accessories

Seal kit	SK10-S3N-OO	- Note: Buna N
	SK10-S3V-MM	- Note: Fluorocarbon
	SK10-S3P-OO	- Note: Poluurethane

Order Code

ORDERING INFORMATION:

EP10-S36X-X-XX-XXX

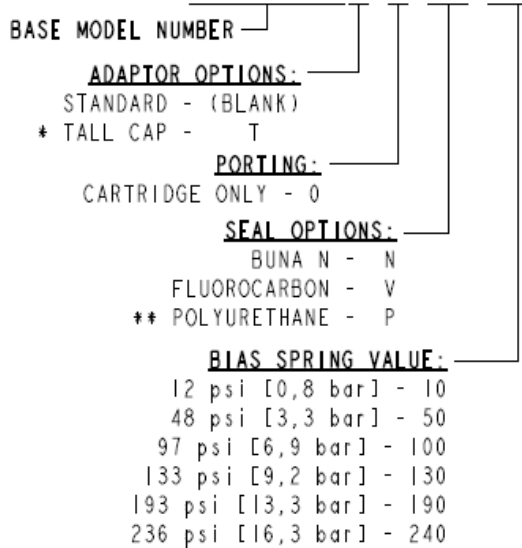

* "T" TALL CAP REQUIRED FOR 190, AND 240 BIAS SPRINGS.

** REQUIRED FOR PRESSURES OVER 3500 psi [241 bar].

Model Options

EP10-S36C-H-J-R

C Adaptor Option

CODE	DESCRIPTION
BLANK	Standard Cap
T	Tall Cap

H Line Body

CODE	DESCRIPTION
0	No Body
10T	Aluminum body SAE #10 ports
10TD	Ductile Iron body SAE #10 ports

J Seal

CODE	DESCRIPTION
N	Buna-N
V	Fluorocarbon
P	Polyurethane



R Spring

CODE	DESCRIPTION
10	10 psi Bias Spring
50	50 psi Bias Spring
100	100 psi Bias Spring
130	130 psi Bias Spring
190	190 psi Bias Spring
240	240 psi Bias Spring