

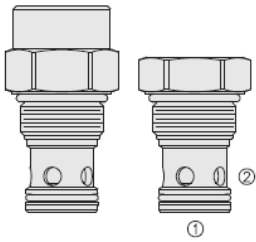

Overview



Description

The HCV16-20X is a screw-in, cartridge style, hydraulic check valve for use as a blocking or load-holding device for high pressure applications.

Operation

The check valve allows flow from port 1 to 2, while normally blocking flow in the opposite direction. The cartridge valve has a fully guided poppet which is spring biased closed until sufficient pressure is applied at port 1 to open to port 2.

Features

- Hardened seat for long life and low leakage.
- Optional bias springs for back-pressure application flexibility.
- All HyPerformance products are tested to the rigorous standards of the NFPA specification T2.6.1
- All HyPerformance valves are tested at a verification level of 90% and an assurance of 99%.

Symbol

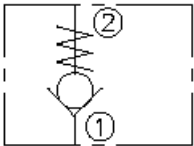

Ratings

Pressure Ratings

Pressure rating	350 bar (5075 psi) 420 bar (6090 psi)	- Note: 10% cycle life
Proof pressure	690 bar (10000 psi)	
Burst pressure	1380 bar (20000 psi)	

Flow Ratings

Flow rating	151 lpm (40 gpm)	- Note: At 350 bar (5075 psi)
Maximum internal leakage	0.25 ml/min (5 drops/min)	

Other Ratings

Cycle life	One million cycles
------------	--------------------

Temperature Ratings

Operating fluid temperature	-40 to 100 °C (-40 to 212 °F)	- Note: With buna N seals
	-26 to 204 °C (-15 to 400 °F)	- Note: With fluorocarbon seals
	-54 to 107 °C (-65 to 225 °F)	- Note: With urethane seals
Storage temperature	-40 to 70 °C (-40 to 160 °F)	
Ambient temperature	-40 to 90 °C (-40 to 194 °F)	

Operating Parameters

Fluids	Mineral based or synthetic hydraulic fluid with lubricating properties
Fluid viscosity range	7.4 to 420 cSt
Maximum operating contamination level	18/16/13 per ISO 4406

Properties

Unit weight	0.34 kg (0.74 lb)	- Note: Regular adaptor
	0.46 kg (1.02 lb)	
	0.60 kg (1.32 lb)	
Internal wetted surface area	168 cm ² (26.01 in ²)	- Note: Tall adaptor for 100 and 150 psi springs
	245 cm ² (37.98 in ²)	- Note: Tall adaptor for 200 psi spring
	290 cm ² (44.89 in ²)	



Performance

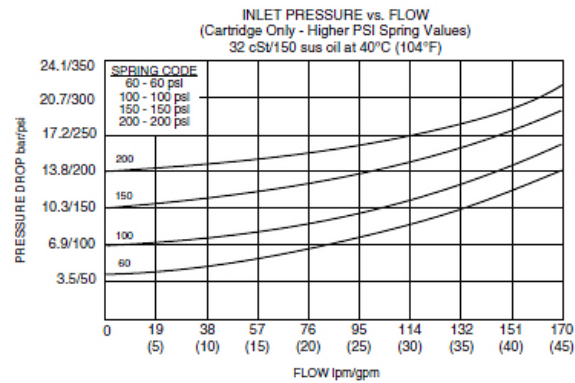
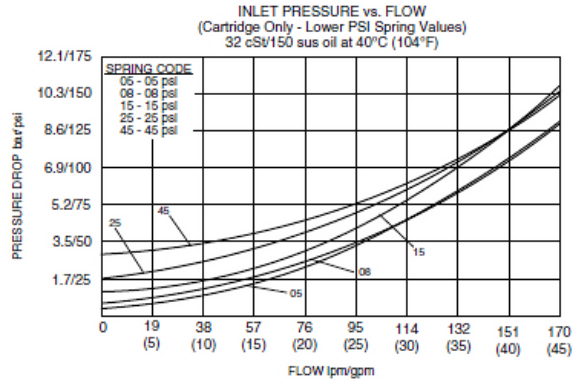
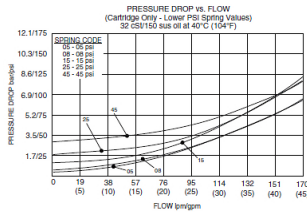
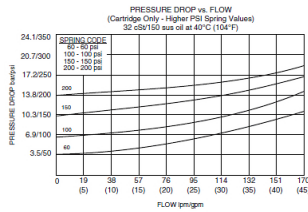

Dimensions

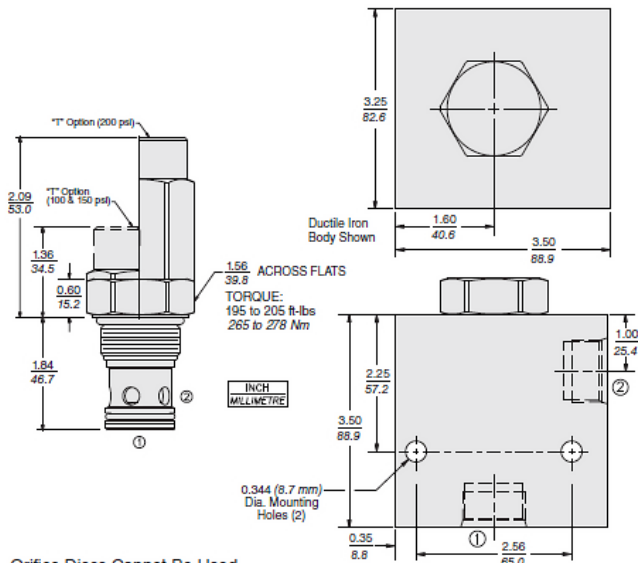

Orifice Discs Cannot Be Used with this Valve due to HyPerformance™ Cavity.

Installation Specifications

Cavity	HVC16-2	
Cartridge installation torque	258 to 285 N-m (190 to 210 ft-lb) 237 to 250 N-m (175 to 185 ft-lb)	- Note: Steel/ductile iron cavity - Note: Aluminum cavity
Orientation restriction	None	

Accessories

Seal kit	SK16-2N-T SK16-2V-T SK16-2U-O	- Note: Buna N - Note: Fluorocarbon - Note: Urethane
----------	-------------------------------------	---



Order Code

HCV16-20 - - -

Adapter Option
 Regular Blank
 **Tall Cap T

** Required for 6.9 bar (100 psi), 10.3 bar (150 psi) and 13.8 bar (200 psi) spring options

Porting
 Cartridge Only 0
 SAE 16 16HT
 1 in. BSP* 8HB
 *BSP Body; U.K. Mfr. Only

Bias Spring Value

05	0.35 bar (5 psi)
08	0.6 bar (8 psi)
15	1.0 bar (15 psi)
25	1.7 bar (25 psi)
45	3.5 bar (45 psi)
60	4.1 bar (60 psi)
100	6.9 bar (100 psi)
150	10.3 bar (150 psi)
200	13.8 bar (200 psi)

Seals
 U PPDI Urethane

Note: PPDI Urethane seals are recommended for pressures over 241 bar (3500 psi).

Model Options

HCV16-20-H-J-R

H Line Body

CODE	DESCRIPTION
0	No Body

J Seal

CODE	DESCRIPTION
N	Buna-N
V	Fluorocarbon
U	PPDI Urethane

R Spring

CODE	DESCRIPTION
5	5 psi Bias Spring
8	8 psi Bias Spring
15	15 psi Bias Spring
25	25 psi Bias Spring
45	45 psi Bias Spring
60	60 psi Bias Spring