



Overview

Description

This valve is a direct - acting 3 position, 5 port proportional directional control. With port 1 as a load sense port it is a screw in cartridge type for use with general purpose hydraulic fluids.

Features

- Continuous-duty rated solenoid.
- Hardened precision spool and cage for long life.
- Optional coil voltages and terminations.
- Manual override option.
- Optional waterproof E-Coils rated up to IP69K.
- Cartridges are voltage interchangeable.

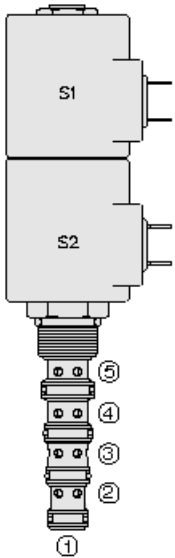

Symbol

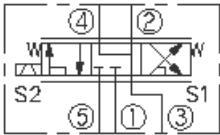

Ratings

Pressure Ratings

Pressure rating 250 bar (3625 psi)

Flow Ratings

Flow rating	22.7 lpm (6.0 gpm)	- Note: SP10-57D
	18.9 lpm (5.0 gpm)	- Note: SP10-57DX
Maximum internal leakage	246 ml/min (15 in ³ /min)	- Note: SP10-57D max at 207 bar (3000 psi)
	164 ml/min (10 in ³ /min)	- Note: SP10-57DX max at 207 bar (3000 psi)

Temperature Ratings

Operating fluid temperature	-40 to 100 °C (-40 to 212 °F)	- Note: With buna N seals
	-26 to 204 °C (-15 to 400 °F)	- Note: With fluorocarbon seals
	-54 to 107 °C (-65 to 225 °F)	- Note: With polyurethane seals
Storage temperature	-40 to 70 °C (-40 to 158 °F)	
Ambient temperature	-40 to 70 °C (-40 to 158 °F)	

Operating Parameters

Fluids	Mineral based or synthetic hydraulic fluid with lubricating properties
Fluid viscosity range	10 to 420 cSt
Maximum operating contamination level	20/18/14 per ISO 4406

Properties

Unit weight	0.30 kg (0.65 lb)	- Note: SP10-57D
	0.34 kg (0.74 lb)	- Note: SP10-57DM
	0.35 kg (0.78 lb)	- Note: SP10-57DB
Internal wetted surface area	267 cm ² (41.4 in ²)	



Performance

ⓐ to ⓔ or ⓖ to ⓓ at 100% current, S1 or S2 energized: - - - - -
ⓐ to ⓖ or ⓔ to ⓓ at 100% current, S1 or S2 energized: - - - - -
32 cSt/150 sus oil at 40°C

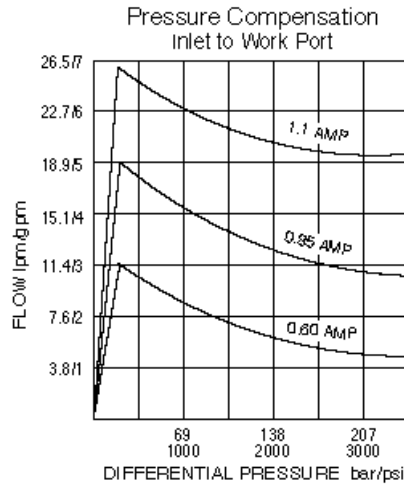
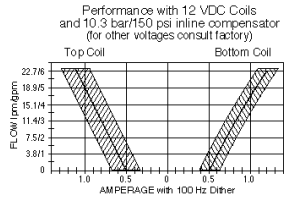
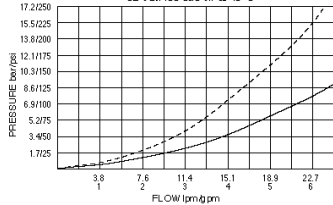

Dimensions

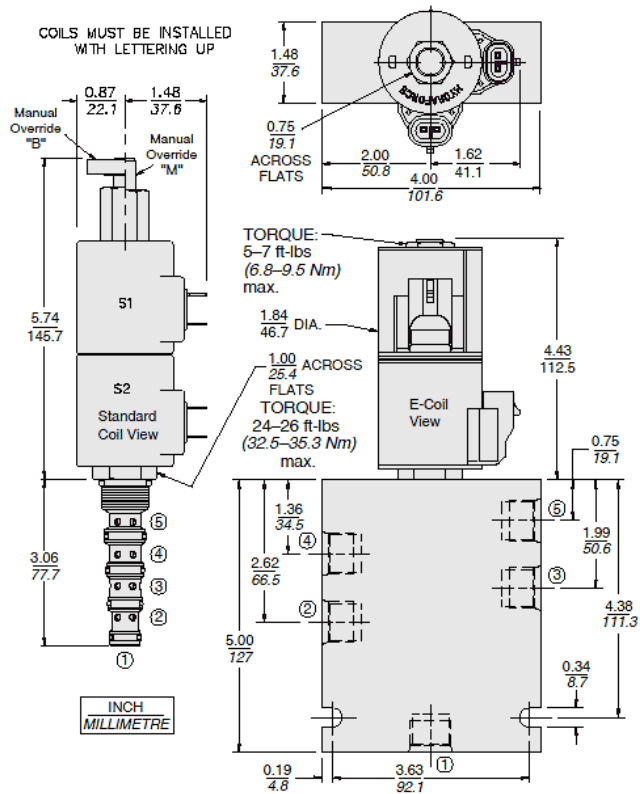

Installation Specifications

Cavity	VC10-5
Cartridge installation torque	32.5 to 35.3 N-m (24 to 26 ft-lb)
Maximum allowable torque	61 N-m (45 ft-lb)
Coil nut torque	6.8 to 9.5 N-m (5 to 7 ft-lb)
Orientation restriction	None

Accessories

Seal kit SK10-5X-MMMM - **Note:** X = seal option

Order Code

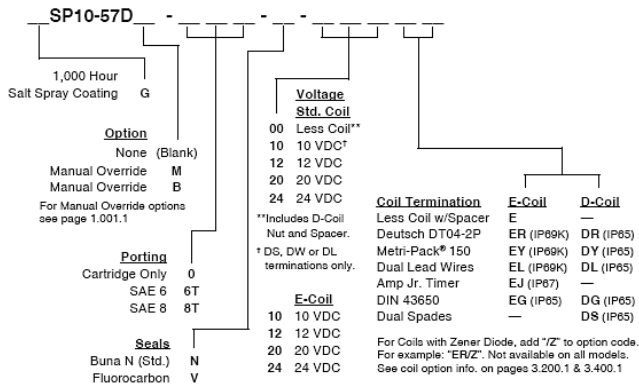

Model Options

SP10-57DE-H-J-L

E Manual Override

CODE	DESCRIPTION
B	Momentary Push/Pull Override, 1.5" Diameter Aluminum Knob
BLANK	NONE
K	Three Position Override, 1.5" Diameter Aluminum Knob
M	Momentary Push/Pull Override, Red Knurled Knob

H Line Body

CODE	DESCRIPTION
0	No Body
6T	Aluminum SAE 6
8T	Aluminum SAE 8

J Seal

CODE	DESCRIPTION
N	Buna-N
V	Fluorocarbon
P	Polyurethane
U	PPDI Urethane

L Coil

CODE	DESCRIPTION
0	No Coil, D-Coil Spacer
0E	No Coil, E-Coil Spacer
10DG	10 VDC, D-Coil, DIN 43650
10DL	10 VDC, D-Coil, Dual Lead Wires
10DS	10 VDC, D-Coil, Dual Spade
10EL	10 VDC, E-Coil, Dual Lead Wires
10ER	10 VDC, E-Coil, Deutsch
12DG	12 VDC, D-Coil, DIN 43650
12DL	12 VDC, D-Coil, Dual Lead Wires, 18 inches long
12DL/36	12 VDC, D-Coil, Dual Lead Wires, 36 inches long
12DL/W	12 VDC, D-Coil, Dual Lead Wires with Weatherpak
12DR	12 VDC, D-Coil, Deutsch



CODE	DESCRIPTION
12DS	12 VDC, D-Coil, Dual Spade
12EG	12 VDC, E-Coil, DIN 43650
12EJ	12 VDC, E-Coil, AMP Jr.
12EL	12 VDC, E-Coil, Dual Lead Wires, 18 inches long
12EL/36	12 VDC, E-Coil, Dual Lead Wires, 36 inches long
12ER	12 VDC, E-Coil, Deutsch
12EY	12 VDC, E-Coil, Metri-Pack 150
20DS	20 VDC, D-Coil, Dual Spade
20ER	20 VDC, E-Coil, Deutsch
24AG	24 VDC, D-Coil, DIN 43650
24AP	24 VDC, D-Coil, 1/2" Conduit and Dual Lead Wires
24DG	24 VDC, D-Coil, DIN 43650
24DL	24 VDC, D-Coil, Dual Lead Wires
24DL/W	24 VDC, D-Coil, Dual Lead Wires with Weatherpak
24DP	24 VDC, D-Coil, 1/2" Conduit and Dual Lead Wires
24DR	24 VDC, D-Coil, Deutsch
24DS	24 VDC, D-Coil, Dual Spade
24EG	24 VDC, E-Coil, DIN 43650
24EJ	24 VDC, E-Coil, AMP Jr.
24EL	24 VDC, E-Coil, Dual Lead Wires, 18 inches long
24EL/36	24 VDC, E-Coil, Dual Lead Wires, 36 inches long
24ER	24 VDC, E-Coil, Deutsch
24EY	24 VDC, E-Coil, Metri-Pack 150
36DS	36 VDC, D-Coil, Dual Spade