

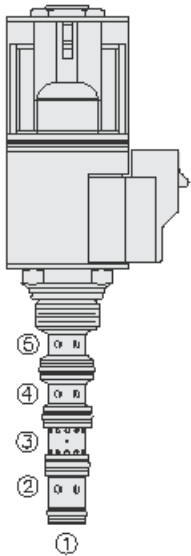

Overview



Description

This SP08-58DX valve is a direct-acting 3 position, 5 port proportional directional control. With port 1 as a load sense port, it is a screw in cartridge type for use with general purpose hydraulic fluids.

Features

- Continuous-duty rated solenoid.
- Hardened precision spool and cage for long life.
- Optional coil voltages and terminations.
- Manual override option.
- Efficient wet-armature construction.
- Optional waterproof E-Coils rated up to IP69K.
- Cartridges are voltage interchangeable.
- Compact size.

Symbol

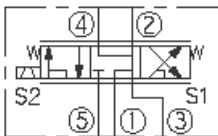

Ratings

Pressure Ratings

Pressure rating	207 bar (3000 psi) verification levels	- Note: Per NFPA t2.6.1 r2-2000 using 99.9 assurance and 90%
Proof pressure	345 bar (5000 psi)	- Note: SP08-58D
Burst pressure	655 bar (9500 psi)	- Note: SP08-58D

Flow Ratings

Minimum flow rating	7.6 lpm (2.0 gpm)	- Note: S1, s2. Based on with pressure compensator at maximum control current. (see performance graphs) 10.3 bar (150 psid)
Maximum internal leakage	164 ml/min (10 in ³ /min)	- Note: At valve de-energized from port 5 to ports 2 or 4 (ports 3 and 1 are blocked) 207 bar (3000 psi)
Hysteresis flow	0.8 lpm (0.2 gpm)	- Note: Maximum, from 1.5 to 7.57 lpm (0.4 to 2.0 gpm)

Temperature Ratings

Operating fluid temperature	-40 to 100 °C (-40 to 212 °F)	- Note: With buna N seals
	-26 to 204 °C (-15 to 400 °F)	- Note: With fluorocarbon seals
	-54 to 107 °C (-65 to 225 °F)	- Note: With polyurethane seals
Storage temperature	-40 to 70 °C (-40 to 160 °F)	
Ambient temperature	-40 to 70 °C (-40 to 160 °F)	

Operating Parameters

Fluids	Mineral based or synthetic hydraulic fluid with lubricating properties
Fluid viscosity range	7.4 to 420 cSt

Properties

Unit weight	0.17 kg (0.38 lb)	- Note: SP08-58D
	0.23 kg (0.50 lb)	- Note: SP08-58DM
	0.25 kg (0.55 lb)	- Note: SP08-58DB
Internal wetted surface area	178 cm ² (27.6 in ²)	



Electrical Parameters

Valve inductance	124 mH	- Note: S1
	97 mH	- Note: S2
Maximum control current	1.0 A	- Note: D-coil 12 Vdc
Threshold current	12 Vdc	- Note: (d-coil) see performance graphs
Dither PWM frequency	90 to 110 Hz	

Performance

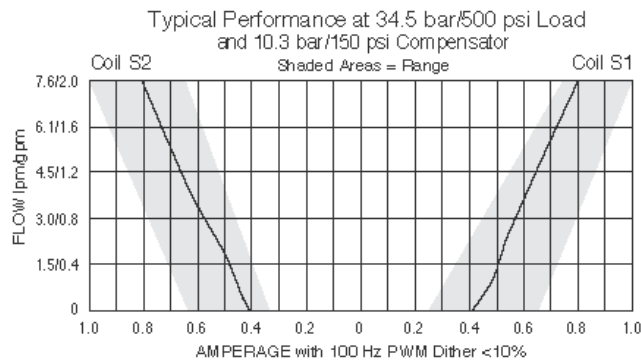
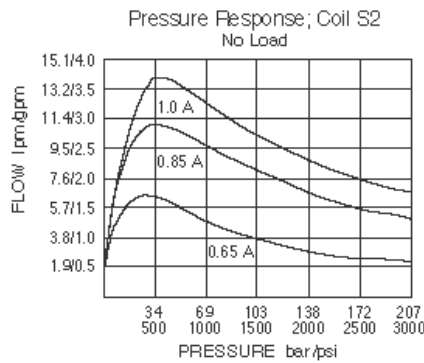
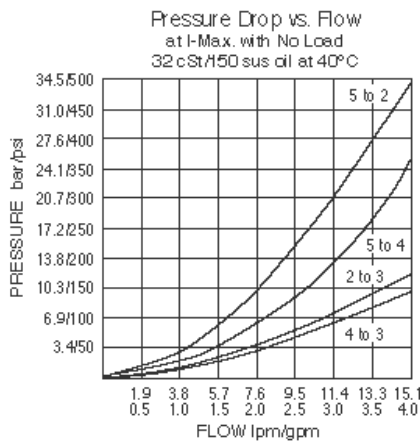
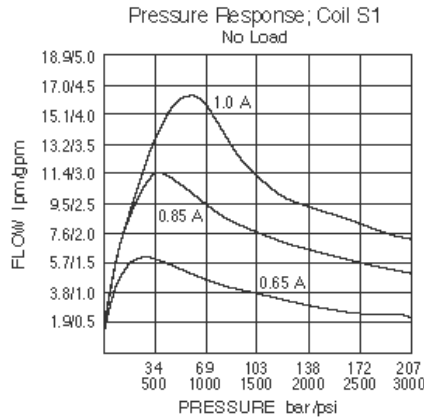
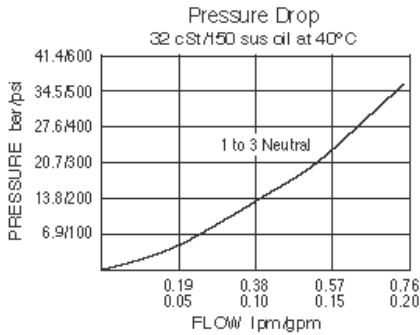



Dimensions

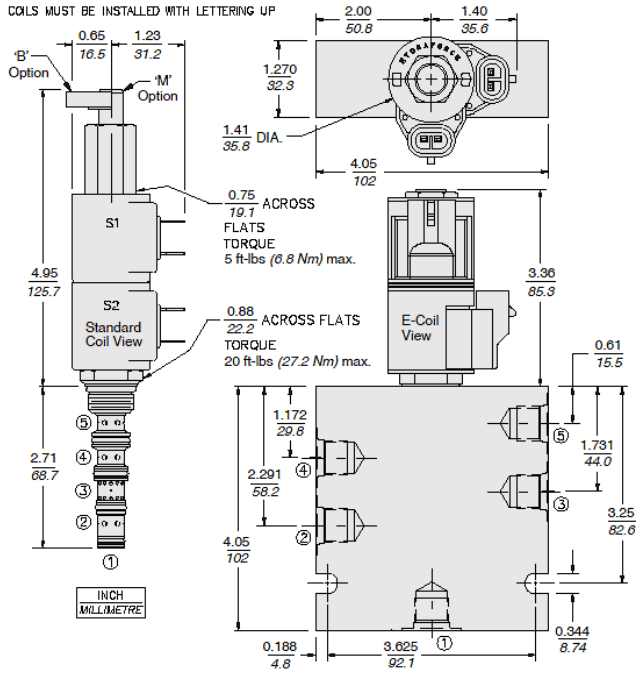

Installation Specifications

Cavity	VC08-5
Cartridge installation torque	33.9 to 40.7 N-m (25 to 30 ft-lb)
Maximum allowable torque	54.2 N-m (40 ft-lb) - Note: Aluminum
Coil nut torque	5.4 to 6.8 N-m (4 to 5 ft-lb)
Orientation restriction	None

Accessories

Seal kit	SK08-5X-MMMM	- Note: X = seal option
Housings		
Coils		

Order Code

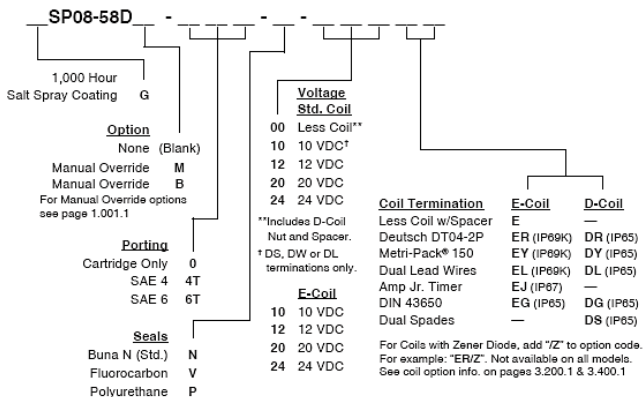

POSITION	CODE	DESCRIPTION
		SP08-58DE-H-J-L
E		Manual Override
E	B	Momentary PushPull Override, 1.5" Diameter Aluminum Knob
E	BLANK	NONE
E	K	Three Position Override, 1.5" Diameter Aluminum Knob
E	M	Momentary Push/Pull Override, Red Knurled Knob



POSITION	CODE	DESCRIPTION
H		Line Body
H	0	No Body
H	6T	Aluminum SAE 6
J		Seal
J	N	Buna-N
J	V	Fluorocarbon
J	P	Polyurethane
L		Coil
L	0	No Coil, D-Coil Spacer
L	0E	No Coil, E-Coil Spacer
L	10DL	10 VDC, D-Coil, Dual Lead Wires
L	10DS	10 VDC, D-Coil, Dual Spade
L	10EL	10 VDC, E-Coil, Dual Lead Wires, 18 inches long
L	10EL/36	10 VDC, E-Coil, Dual Lead Wires, 36 inches long
L	10ER	10 VDC, E-Coil, Deutsch
L	12DG	12 VDC, D-Coil, DIN 43650
L	12DL	12 VDC, D-Coil, Dual Lead Wires, 18 inches long
L	12DL/36	12 VDC, D-Coil, Dual Lead Wires, 36 inches long
L	12DL/W	12 VDC, D-Coil, Dual Lead Wires with Weatherpak
L	12DR	12 VDC, D-Coil, Deutsch
L	12DS	12 VDC, D-Coil, Dual Spade
L	12EG	12 VDC, E-Coil, DIN 43650
L	12EJ	12 VDC, E-Coil, AMP Jr.
L	12EL	12 VDC, E-Coil, Dual Lead Wires, 18 inches long
L	12EL/36	12 VDC, E-Coil, Dual Lead Wires, 36 inches long
L	12ER	12 VDC, E-Coil, Deutsch
L	12EY	12 VDC, E-Coil, Metri-Pack 150
L	20DG	20 VDC, D-Coil, DIN 43650
L	20DS	20 VDC, D-Coil, Dual Spade
L	20ER	20 VDC, E-Coil, Deutsch
L	24AG	24 VDC, D-Coil, DIN 43650
L	24AP	24 VDC, D-Coil, 1/2" Conduit and Dual Lead Wires
L	24DG	24 VDC, D-Coil, DIN 43650
L	24DL	24 VDC, D-Coil, Dual Lead Wires, 18 inches long
L	24DL/36	24 VDC, D-Coil, Dual Lead Wires, 36 inches long
L	24DL/W	24 VDC, D-Coil, Dual Lead Wires with Weatherpak
L	24DR	24 VDC, D-Coil, Deutsch
L	24DS	24 VDC, D-Coil, Dual Spade
L	24EG	24 VDC, E-Coil, DIN 43650
L	24EJ	24 VDC, E-Coil, AMP Jr.
L	24ER	24 VDC, E-Coil, Deutsch
L	24EY	24 VDC, E-Coil, Metri-Pack 150
L	36DG	36 VDC, D-Coil, DIN 43650



POSITION	CODE	DESCRIPTION
L	36DS	36 VDC, D-Coil, Dual Spade